

B
Actuator Products

Actuator Products

Tie Rod Cylinders

3MA Series - Economy NFPA Cylinder

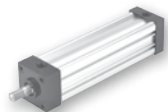

- Bore sizes 1-1/2 through 5 inch
- 18 standard mounting styles
- Pressures up to 250 PSIG
- Temperatures -10°F to 165°F
- Aluminum body construction

B6

4MA / 4ML Series - Flexible NFPA Cylinder

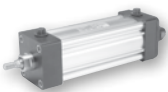

- Bore sizes 1-1/2 through 8 inch
- 20 standard mounting styles
- Pressures up to 250 PSIG
- Temperatures -50°F to 250°F
- Aluminum body construction

B16

3MAJ / 4MAJ - Rodlock Cylinder

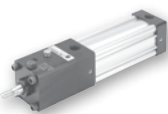

- Bore sizes 1-1/2 through 8 inch
- 17 standard mounting styles
- Pressures up to 100 PSIG
- Temperatures -10°F to 165°F
- Aluminum body construction

B40

4MNR Series - Non-Rotating Cylinder

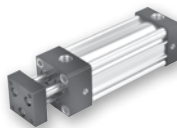

- Bore sizes 1-1/8 through 4 inch
- 14 standard mounting styles
- Pressures up to 250 PSIG
- Temperatures -10°F to 165°F
- Aluminum body construction

B58

P1D Series - ISO 15552 / ISO 6431



- 6 available for maximum flexibility
- Bore sizes 32mm through 200mm
- 10 standard mounting styles
- Pressures up to 145 PSIG
- Temperatures -10°F to 250°F
- Aluminum body construction

B65

Round Body Cylinders

SR / SRM / SRD / SRDM Series - Non-Repairable



- Bore sizes 5/16 through 3 inch
- 28 mounting styles
- Pressures up to 250 PSIG
- Temperatures -10°F to 165°F
- Stainless steel body construction

B83

SRX Series - Position Feedback



- Bore sizes 1-1/16 through 3 inch
- Continuous position feedback
- Pressures up to 150 PSIG
- Temperatures 40°F to 165°F
- Stainless steel body construction

B109

P1L Series - Repairable



- Bore sizes 20mm through 100mm
- 9 mounting styles
- Pressures up to 145 PSIG
- Temperatures -10°F to 250°F
- Aluminum body construction

B117

P1A Series - ISO Non-Repairable



- Bore sizes 10mm through 25mm
- 5 mounting styles
- Pressures up to 145 PSIG
- Temperatures -40°F to 302°F
- Stainless steel body construction

B132

P Series - Repairable



- Bore sizes 1-1/8 through 4 inch
- 4 mounting styles
- Pressures up to 150 PSIG
- Temperatures -10°F to 250°F
- Aluminum body construction

B136

B

Pictorial Index
Actuator Products

Compact Cylinders

P1Q Series - Economy Compact Cylinder



- Bore sizes 12mm through 100mm
- 4 flexible mounting options
- Pressures up to 10 PSIG
- Temperatures 23°F to 158°F
- Aluminum body construction

B143

P1M Series - Compact Cylinder



- Bore sizes 12mm through 100mm
- 6 mounting options
- Pressures up to 145 PSIG
- Temperatures -4°F to 250°F
- Aluminum body construction

B151

LP / LPM Series - Compact Cylinder



- Bore sizes 9/16 through 4 inch
- 6 mounting styles
- Pressures up to 150 PSIG
- Temperatures -10°F to 200°F
- Aluminum body construction

B163

Guided Cylinders

P5T Series - Compact Guided



- Bore sizes 16mm through 100mm
- Pressures up to 145 PSIG
- Temperatures 0°F to 250°F
- Aluminum body construction
- Flexible porting: top, rear, side

B169

P5L Series - Guided



- Bore sizes 20mm through 100mm
- Direct mounting
- Pressures up to 145 PSIG
- Temperatures 0°F to 250°F
- Extruded aluminum body construction

B176

HB Series - Heavy Duty Guided



- Bore sizes 1-1/2 through 2-1/2 inch
- Thrust, reach and compact versions available
- Air service pressure up to 250 PSIG, hydraulic service up to 750 PSIG
- Temperatures 0°F to 250°F
- Aluminum body construction
- Rod lock version available

B202

P5E Series - P1D ISO Guided



- Bore sizes 32mm through 100mm
- Pressures up to 145 PSIG
- Temperatures 14°F to 165°F
- Aluminum body construction
- Rod lock version available

B210

B
Pictorial Index
Actuator Products

Rodless Cylinders

OSP-P Series - Band Type Rodless

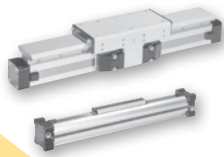

- Bore sizes 10mm through 80mm
- Pressures to max. 8 bar
- Temperatures -10°F to 80°F
- Aluminum body construction

B216

P1X Series - Band Type Rodless



- 7 bore sizes 16mm through 63mm
- Integral sensor mounting rail
- Pressures 7 to 100 PSIG
- Temperatures 40°F to 140°F
- Aluminum body construction

B234

P1Z Series - Magnetically Coupled Rodless

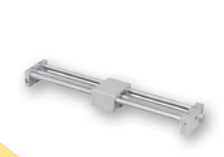

- 3 bore sizes 16mm, 20mm & 32mm
- Pressures 29 to 100 PSIG
- Temperatures 15°F to 140°F
- Stainless steel body construction

B246

GDL Series - Rails & Cassettes



- 6 sizes available
- Speed up to 10m/s (33 ft/s)
- Temperatures -10°C to 80°C
- Aluminum alloy rail
- Aluminum body construction

B258

Rotary Actuators

PV Series - Vane Rotary



- 8 model sizes
- Single or double vane models
- Pressures to 150 PSIG
- Temperatures 30°F to 250°F
- 7 to 1800 lb-in output torque

B263

PRN(A) Series - Vane Rotary



- 5 miniature and 4 standard models
- Temperatures -23°F to 176°F
- 1.33 to 2355 in-lb torque at 100 PSIG

B267

PTR Series - Rack & Pinion Rotary

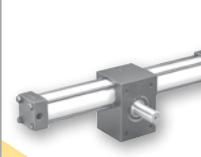

- Bore sizes 1 through 3-1/4 inch
- Pressures to 250 PSIG
- Temperatures 0°F to 250°F
- 39 to 2281 lb-in output torque

B272

HP Series - Large Rack & Pinion Rotary

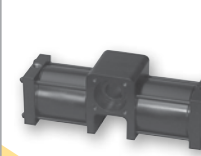

- 2 large bore models
- 3 standard rotations
- Pressures to 100 PSIG
- Temperatures 0°F to 250°F
- 4500 and 10,000 lb-in output at 100 PSIG

B275

P1V-S Series - Air Motors

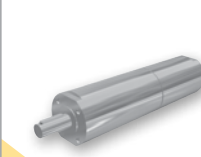

- Power from 20 through 1200 watts
- Speeds 5 to 24,000 RPM
- Pressures to max. 7 bar
- Temperatures -30°C to 100°C

B278

B

Pictorial Index
Actuator Products

Automation Products

Grippers



B281

- Grip forces to 44,000N
- Parallel or Angular
- 2 or 3 jaw
- Pneumatic or electric
- Temperature to 300°F
- Magnetic piston standard
- Clean room

Actuator Accessories

Linear Alignment Couplers

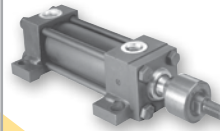

B335

- 12 standard thread sizes
- Maximum reliability for trouble-free operation, long life and lower operating costs
- Increased cylinder life by reducing wear on piston and rod bearings
- Stainless steel versions available

Slide Tables



B314

- 6 bore sizes: 6mm to 25mm
- Strokes to 150mm
- Integration of linear rail and dual bore cylinder
- Available with adjustable stroke and shock absorbers
- Magnetic piston standard

4TK Series - Air Oil Tanks

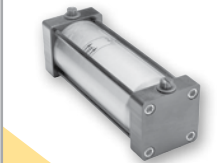

B336

- 6 standard bore sizes
- Lightweight aluminum / fiberglass design
- 2 fluid flow baffles reduce agitation and aeration
- 8 standard mounting styles

Rotary Tables

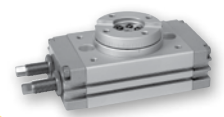

B326

- 4 bore sizes: 16mm to 32mm
- Dual rack and pinion with integrated bearing
- Adjustable rotation standard 0 to 190 degrees
- Available with optional shock absorbers

PRL Series - Stand Alone Rodlock

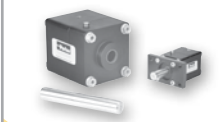

B337

- 5 different sizes
- Large holding forces
- 2 different mounting styles
- Case-hardened rod material available

Escapements

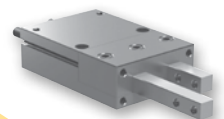

B328

- 3 bore sizes: 14mm to 27mm
- Locking key ensures part separation and eliminates jams
- Adjustable retract stops
- Sealed design repels contaminants
- Dowel holes in body for precision applications

Electronic Sensors

Sensors



B339

- Solid state
- Reed
- NAMUR
- Proximity

Shock Absorbers

Shock Absorbers



B361

- Miniature - self-compensating
- Heavyweight - soft contact and self-compensating
- Miniature - soft contact and self-compensating
- Magnum series - adjustable
- Heavy - self-compensating
- Heavy - adjustable

3MA Series

- NFPA interchangeable economy series
- Bore sizes – 1-1/2", 2", 2-1/2", 3-1/4", 4" and 5"
- Available in any practical stroke length
- 18 standard modular mounting styles available
- Extruded-profile aluminum body with integrated switch grooves
- Single rod end or double rod end options available
- Cushions – standard and adjustable at both ends, optional non-cushioned
- NPT porting standard
- RoHS compliant

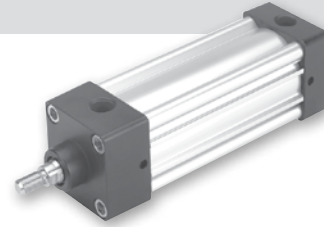

Operating information

Operating pressure:	250 PSIG (17 bar)
Temperature range:	-10°F to 165°F (-23°C to 74°C)
Filtration requirements:	40 micron, dry filtered air

Ordering information

2.00	C	J	3MA	U	1	4	A	C	6.000
Bore size 1.50 2.00 2.50 3.25 4.00 5.00	Double rod cylinder ⁵ Specify "K" only if double rod cylinder is required.	Mounting style Specify mounting style code (see table on following page).	Series 3MA	Ports Standard (NPTF)	Seals Blank Standard (nitrile seals) E Fluorocarbon rod wiper and rod seal only ²	Piston rod number Standard (rod code number 1) ³	Cushion cap end C Standard (cushioned cap end) Blank Non-cushioned cap end	Stroke length Specify stroke length required in inches.	Piston rod thread type A Standard (UNF unified thread) W BSF British fine M* Metric
Cushion head end C Standard (cushioned head end) Blank Non-cushioned head end	Cylinder construction Blank* Standard (extruded body, standard round lobe orientation) A* Extruded body, round lobe orientation rotated 90 degrees from standard N* Extruded body, round lobe orientation rotated 180 degrees from standard Z* Extruded body, round lobe orientation rotated 270 degrees from standard T Aluminum round tube and carbon steel tie rods and nuts		Special modification Specify "S" only for special modification other than rod end, and then describe modification in item notes.		Piston rod thread style 4 Small male 8 Intermediate male 9 Short female 55 For use with split coupler ⁴ 3 Special (and specify all dimensions required)		Rod material code Blank Standard Y 17-4 PH stainless steel J 303 stainless steel S 316 stainless steel		
* Please reference catalog 0900P-E, table on page B10. Only applies to 1-1/2" to 4" bore size.									
Piston type									
Blank	Standard (lipseals and magnetic ring) ⁵								
1	Lipseals, no magnetic ring ⁵								
2	Lipseals, no magnetic ring (aluminum piston)								
3	Lipseals and magnetic ring (aluminum piston)								
4	Bumper seals, no magnetic ring								
6	Bumper seals and magnetic ring								
B	Lipseals, 1/4" thick bumpers both ends ¹								
H	Lipseals, 1/4" thick bumper head end ¹								
C	Lipseals, 1/4" thick bumper cap end ¹								
D	Lipseals and magnetic ring, 1/4" thick bumpers both ends ¹								
F	Lipseals and magnetic ring, 1/4" thick bumper head end ¹								
R	Lipseals and magnetic ring, 1/4" thick bumper cap end ¹								

- 1 Addition of 1/4" bumper results in a 1/4" stroke loss per bumper, per end. For example, a 6" stroke cylinder with 1/4" bumpers at both ends (option B) has an effective stroke of 5-1/2".
- 2 Used for external chemical compatibility applications, not high temperature.
- 3 Review Piston Rod Selection Chart, please reference catalog 0900P-E, page A14 to determine proper piston rod diameter. (Note: 3MA has only one rod diameter per bore size, so proper piston rod diameter from chart result may lead to bore size change). For oversize rod within the same bore size, please see 4MA section.
- 4 For additional information regarding this style, please reference catalog 0900P-E, page B105. If non-standard Rod Material Code is required with this option, please place an "S" for special in Special Modification field and specify rod material in the item notes.
- 5 Double rod cylinders not available with composite piston type.

For ordering purposes, when special options or common modifications are requested, the factory will assign a sequential part number in place of the model number.



B
 Tie Rod Cylinders
 Actuator Products
 3MA Series
 4MA/4ML Series
 3MAJ/4MAJ Series
 4MNR Series
 P1D Series

3MA Mounting Styles for 1-1/2" to 5" Bore

Mounting style	NFPA mounting	Description	Bore size
TEF	MX5/MS4	Sleeve Nut with Side Tap (standard mount)	1-1/2 - 5
T	MX0	No Mount (same construction as TEF)	1-1/2 - 5
TE	MX5	Sleeve Nut (same construction as TEF)	1-1/2 - 5
F	MS4	Side Tap (same construction as TEF)	1-1/2 - 5
J	MF1	Head Rectangular Flange	1-1/2 - 5
H	MF2	Cap Rectangular Flange	1-1/2 - 5
TB	MX3	Tie Rods Extended Head End	1-1/2 - 5
TC	MX2	Tie Rods Extended Cap End	1-1/2 - 5
TD	MX1	Tie Rods Extended Both Ends	1-1/2 - 5

Mounting style	NFPA mounting	Description	Bore size
C	MS2	Side Lug	1-1/2 - 5
CB	MS1	Side End Angle	1-1/2 - 5
G	MS7	Side End Lug	1-1/2 - 4
NB	N/A	Base Bar	1-1/2 - 4
BB	MP1	Cap Fixed Clevis	1-1/2 - 5
BC	MP2	Cap Detachable Clevis	1-1/2 - 5
BE	MP4	Cap Detachable Eye	1-1/2 - 4
DD	MT4	Intermediate Trunnion	1-1/2 - 5
KTEF*	MDX5/ MDS4	Double Rod End, TEF Mount	1-1/2 - 5

* Double rod end cylinders can be ordered with head mountings, i.e. KJ.

B

Tie Rod Cylinders
Actuator Products

3MA
Series

4MA/4ML
Series

3MAJ/4MAJ
Series

4MNR
Series

P1D
Series

Sensors

For sensors see page B339.



3MA Single Rod Dimensioned Drawings (Styles TEF, T, TE and F)

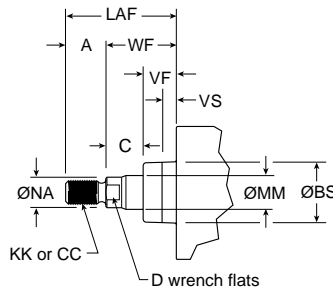
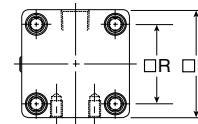
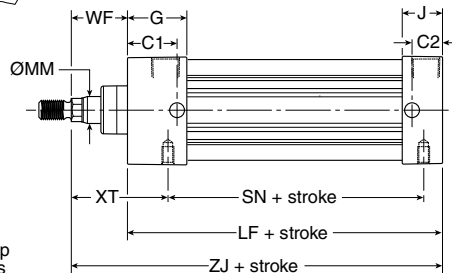
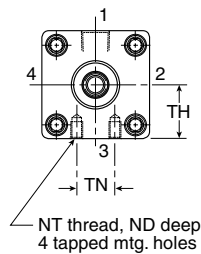
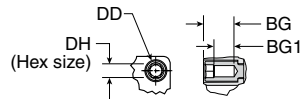
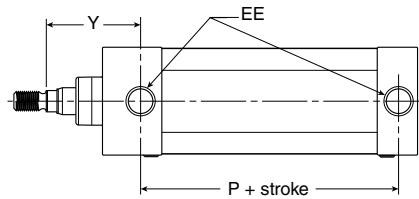
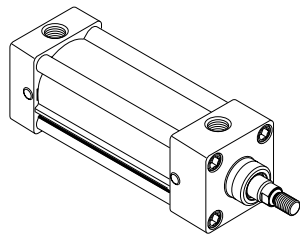

For dimensions of all standard rod end styles, please see next page.
 BS = pilot diameter
 VS = length of pilot diameter

Styles TEF, T, TE and F

Bore size	Rod no.	Rod dia. MM	Thread																
			Style 8 CC	Style 4 & 9 KK	A	AA	BG	BG1	BS	C	C1	C2	D	DD	DH	E	EE (NPTF)	G	
1-1/2	1	5/8	1/2-20	7/16-20	0.750	2.020	0.562	0.374	1.124	0.385	1.000	0.500	1/2	1/4-28	1/4	2.000	3/8	1.438	
2	1	5/8	1/2-20	7/16-20	0.750	2.600	0.562	0.362	1.124	0.385	1.148	0.711	1/2	5/16-24	5/16	2.500	3/8	1.375	
2-1/2	1	5/8	1/2-20	7/16-20	0.750	3.100	0.562	0.362	1.124	0.385	1.117	0.711	1/2	5/16-24	5/16	3.000	3/8	1.344	
3-1/4	1	1	7/8-14	3/4-16	1.125	3.900	0.700	0.500	1.499	0.510	1.350	0.881	7/8	3/8-24	3/8	3.750	1/2	1.594	
4	1	1	7/8-14	3/4-16	1.125	4.700	0.700	0.500	1.499	0.510	1.350	0.881	7/8	3/8-24	3/8	4.500	1/2	1.594	
5	1	1	7/8-14	3/4-16	1.125	5.800	0.781	0.531	1.499	0.510	1.350	0.975	7/8	1/2-20	1/2	5.500	1/2	1.594	

Bore size	Rod no.	Rod dia. MM																Add stroke			
			J	LAF	NA	ND	NT	R	TH	TN	VF	VS	WF	XT	Y	LF	P	SN	ZJ		
1-1/2	1	5/8	0.938	1.750	0.563	0.375	1/4-20	1.430	0.993	0.625	0.615	-	1.000	1.938	1.875	3.625	2.313	2.250	4.625		
2	1	5/8	0.938	1.750	0.563	0.438	5/16-18	1.840	1.243	0.875	0.615	0.250	1.000	1.938	1.875	3.625	2.313	2.250	4.625		
2-1/2	1	5/8	0.938	1.750	0.563	0.625	3/8-16	2.190	1.493	1.250	0.615	0.250	1.000	1.938	1.938	3.750	2.375	2.375	4.750		
3-1/4	1	1	1.125	2.500	0.938	0.750	1/2-13	2.760	1.868	1.500	0.865	0.250	1.375	2.438	2.438	4.250	2.625	2.625	5.625		
4	1	1	1.125	2.500	0.938	0.750	1/2-13	3.320	2.243	2.063	0.865	0.250	1.375	2.438	2.438	4.250	2.625	2.625	5.625		
5	1	1	1.219	2.500	0.938	0.938	5/8-11	4.100	2.743	2.688	0.865	0.250	1.375	2.438	2.438	4.500	2.875	2.875	5.875		

B
 Tie Rod Cylinders
 Actuator Products
 3MA Series
 4MA/4ML Series
 3MAJ/4MAJ Series
 4MNR Series
 P1D Series



3MA Rod End Dimensions

Thread Style 4
 (NFPA Style SM)
 Small Male

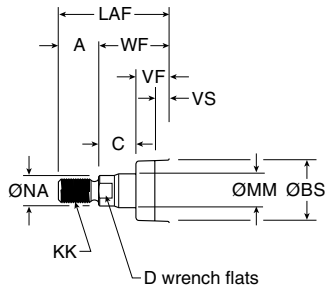

Thread Style 8
 (NFPA Style IM)
 Intermediate Male

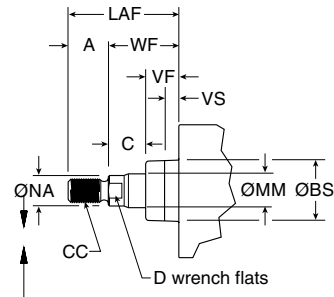

Thread Style 9
 (NFPA Style SF)
 Short Female

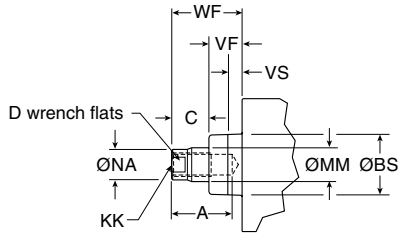

Thread Style 55
 For use with Split Coupler
 (please reference catalog 0900P-E, page B105 for more information)

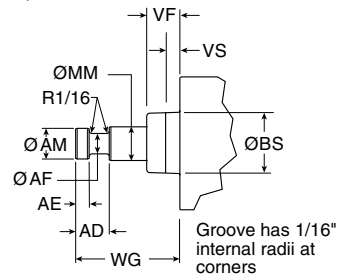

Thread Style 3 - "Special Thread"

Special threads, rod extensions, rod eyes, blanks, etc. are also available.
 To order, specify "Style 3" and give desired dimensions for KK or CC, A and W or WF.
 If otherwise special, please supply dimensioned sketch.

Applies to all rod ends:
 BS = pilot diameter
 VS = length of pilot diameter

Rod End Dimensions

Bore size	Rod no.	Rod dia. MM	Thread																
			Style 8 CC	Style 4 & 9 KK	A	AD	AE	AF	AM	+0.000 -0.004 BS	C	D	LAF	NA	VF	VS	WF	WG	
1-1/2	1	5/8	1/2-20	7/16-20	0.750	0.625	0.250	0.375	0.570	1.124	0.385	1/2	1.750	0.563	0.615	-	1.000	1.750	
2	1	5/8	1/2-20	7/16-20	0.750	0.625	0.250	0.375	0.570	1.124	0.385	1/2	1.750	0.563	0.615	0.250	1.000	1.750	
2-1/2	1	5/8	1/2-20	7/16-20	0.750	0.625	0.250	0.375	0.570	1.124	0.385	1/2	1.750	0.563	0.615	0.250	1.000	1.750	
3-1/4	1	1	7/8-14	3/4-16	1.125	0.938	0.375	0.688	0.950	1.499	0.510	7/8	2.500	0.938	0.865	0.250	1.375	2.375	
4	1	1	7/8-14	3/4-16	1.125	0.938	0.375	0.688	0.950	1.499	0.510	7/8	2.500	0.938	0.865	0.250	1.375	2.375	
5	1	1	7/8-14	3/4-16	1.125	0.938	0.375	0.688	0.950	1.499	0.510	7/8	2.500	0.938	0.865	0.250	1.375	2.375	

B

Tie Rod Cylinders
Actuator Products

3MA Series

4MA/4ML Series

3MAJ/4MAJ Series

4MNR Series

P1D Series



Head Rectangular Flange

Style J
 (NFPA MF1)

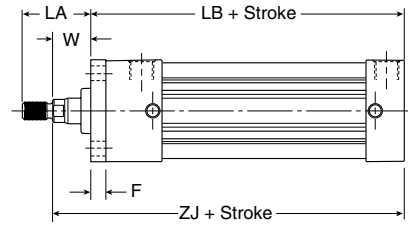
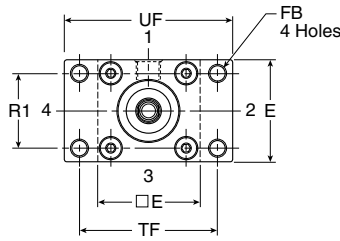
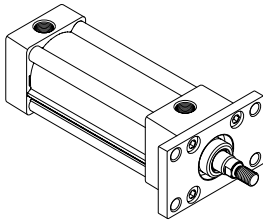

Note: Style J has a W dimension instead of WF and a LA dimension instead of LAF because of the flange installation. Please use dimensions W and LA regarding rod ends only for Style J.
 For reference, $WF = W + F$ and $LA = W + A$.

Cap Rectangular Flange

Style H
 (NFPA MF2)

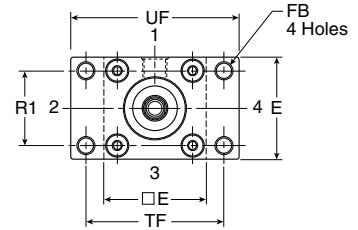
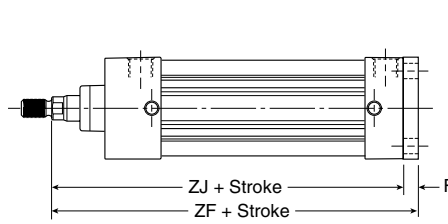
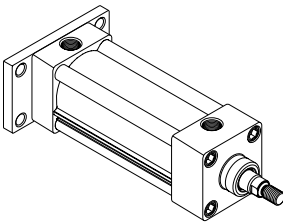

Styles J and H

Bore size	Rod no.	Rod dia. MM	A	E	F	FB	LA	R1	TF	UF	W	Add stroke		
												LB	ZF	ZJ
1-1/2	1	5/8	0.750	2.000	0.375	0.313	1.375	1.430	2.750	3.375	0.625	4.000	5.000	4.625
2	1	5/8	0.750	2.500	0.375	0.375	1.375	1.840	3.375	4.125	0.625	4.000	5.000	4.625
2-1/2	1	5/8	0.750	3.000	0.375	0.375	1.375	2.190	3.875	4.625	0.625	4.125	5.125	4.750
3-1/4	1	1	1.125	3.750	0.625	0.438	1.875	2.760	4.688	5.500	0.750	4.875	6.250	5.625
4	1	1	1.125	4.500	0.625	0.438	1.875	3.320	5.438	6.250	0.750	4.875	6.250	5.625
5	1	1	1.125	5.500	0.625	0.563	1.875	4.100	6.625	7.625	0.750	5.125	6.500	5.875

B
 Tie Rod Cylinders
 Actuator Products
 3MA Series
 4MA/4ML Series
 3MAJ/4MAJ Series
 4MNR Series
 P1D Series



Tie Rods Ext. Head End

Style TB
(NFPA MX3)

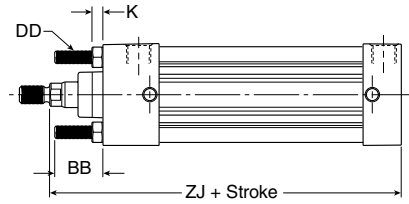
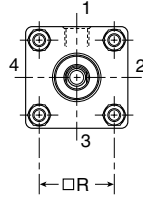
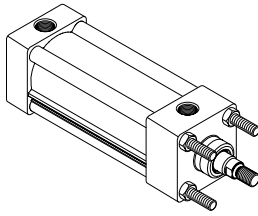

Tie Rods Ext. Cap End

Style TC
(NFPA MX2)

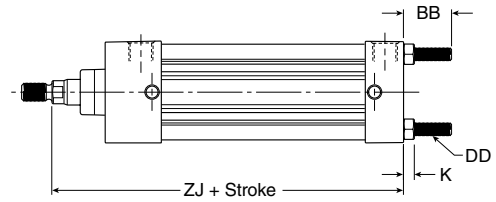
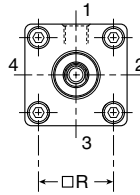
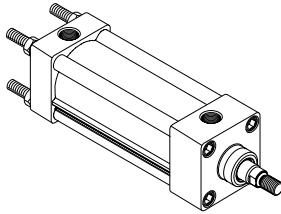

Tie Rods Ext. Both Ends

Style TD
(NFPA MX1)

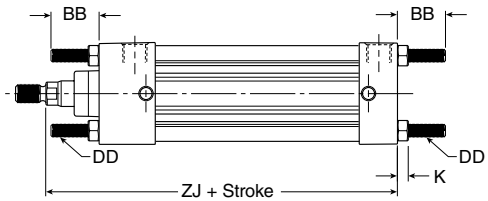
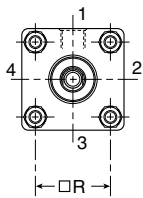
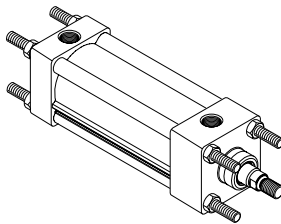

Styles TB, TC and TD

Bore size	Rod no.	Rod dia. MM	BB	DD	E	K	R	Add stroke	
								ZJ	
1-1/2	1	5/8	1.000	1/4-28	2.000	0.250	1.430	4.625	
2	1	5/8	1.125	5/16-24	2.500	0.313	1.840	4.625	
2-1/2	1	5/8	1.125	5/16-24	3.000	0.313	2.190	4.750	
3-1/4	1	1	1.375	3/8-24	3.750	0.375	2.760	5.625	
4	1	1	1.375	3/8-24	4.500	0.375	3.320	5.625	
5	1	1	1.813	1/2-20	5.500	0.438	4.100	5.875	

B
Tie Rod Cylinders
Actuator Products

3MA Series

4MA/4ML Series

3MAJ/4MAJ Series

4MNR Series

P1D Series

Parker Pneumatic

3MA Series

Side Lug

Style C
(NFPA MS2)

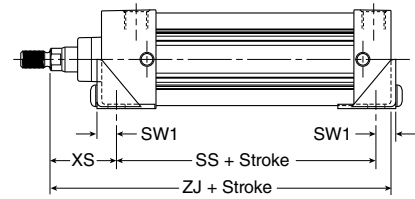
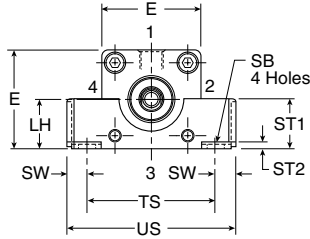
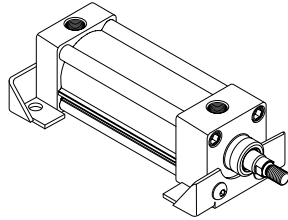

Style C

Bore size	Rod no.	Rod dia. MM	E	LH	SB	ST	ST1	ST2	SW	SW1	TS	US	XS	Add stroke	
														SS	ZJ
1-1/2	1	5/8	2.000	0.993	0.438	0.500	1.000	0.120	0.375	0.495	2.750	3.500	1.375	2.875	4.625
2	1	5/8	2.500	1.243	0.438	0.500	1.250	0.120	0.375	0.495	3.250	4.000	1.375	2.875	4.625
2-1/2	1	5/8	3.000	1.493	0.438	0.500	1.343	0.120	0.375	0.495	3.750	4.500	1.375	3.000	4.750
3-1/4	1	1	3.750	1.868	0.563	0.750	1.500	0.188	0.500	0.688	4.750	5.750	1.875	3.250	5.625
4	1	1	4.500	2.243	0.563	0.750	1.500	0.188	0.500	0.688	5.500	6.500	1.875	3.250	5.625
5	1	1	5.500	2.743	0.813	1.000	1.500	0.250	0.688	0.938	6.875	8.250	2.063	3.125	5.875

Side End Angle*

Style CB
(NFPA MS1)

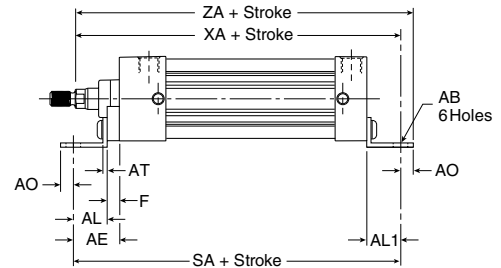
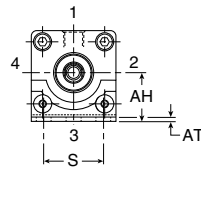
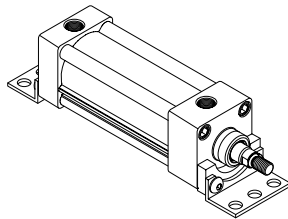

Note: Dimension "S" is for the holes in the mount (not the screw to screw dimension)

*Maximum recommended pressure for this mount is 150 PSIG

Style CB

Bore size	Rod no.	Rod dia. MM	AB	AE	AH	AL	AL1	AO	AT	E	F	S	Add stroke		
													SA	XA	ZA
1-1/2	1	5/8	0.438	1.375	1.188	1.000	1.000	0.375	0.125	2.000	0.375	1.250	6.000	5.625	6.000
2	1	5/8	0.438	1.375	1.438	1.000	1.000	0.375	0.125	2.500	0.375	1.750	6.000	5.625	6.000
2-1/2	1	5/8	0.438	1.375	1.625	1.000	1.000	0.375	0.125	3.000	0.375	2.250	6.125	5.750	6.125
3-1/4	1	1	0.563	1.875	1.938	1.250	1.250	0.500	0.125	3.750	0.625	2.750	7.375	6.875	7.375
4	1	1	0.563	-	2.250	1.875	1.250	0.500	0.125	4.500	-	3.500	7.375	6.875	7.375
5	1	1	0.688	2.000	2.750	1.375	1.375	0.625	0.188	5.500	0.625	4.250	7.875	7.250	7.875



Side End Lug

Style G
 (NFPA MS7)

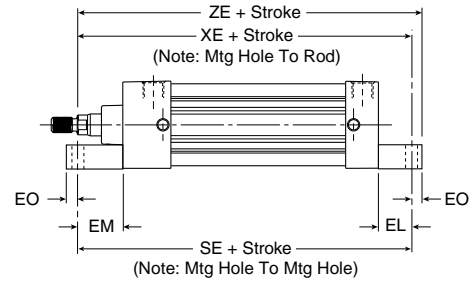
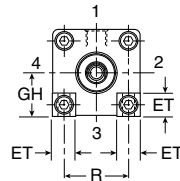
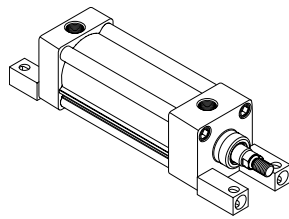

Style G

Bore Size	Rod no.	Rod Dia. MM	E	EB	EL	EM	EO	ET	GH	R	Add stroke		
											SE	XE	ZE
1-1/2	1	5/8	2.000	0.281	0.750	1.125	0.250	0.563	0.993	1.430	5.500	5.375	5.625
2	1	5/8	2.500	0.344	0.938	1.313	0.313	0.688	1.243	1.840	5.875	5.563	5.875
2-1/2	1	5/8	3.000	0.344	1.063	1.438	0.313	0.813	1.493	2.190	6.250	5.813	6.125
3-1/4	1	1	3.750	0.406	0.875	1.500	0.375	1.000	1.868	2.760	6.625	6.500	6.875
4	1	1	4.500	0.406	1.000	1.625	0.375	1.188	2.243	3.320	6.875	6.625	7.000

Base Bar Mount

Style NB

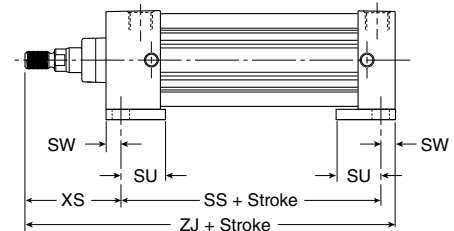
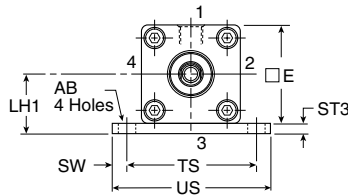
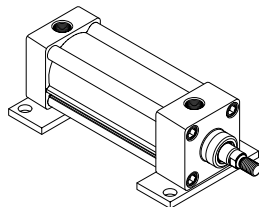

Note: Fasteners for NB base bar mount have been applied with removable threadlocking compound and torqued to bottom of endcaps.

Style NB

Bore size	Rod no.	Rod dia. MM	AB	E	LH1	ST3	SU	SW	TS	US	XS	Add stroke	
												SS	ZJ
1-1/2	1	5/8	0.438	2.000	1.243	0.250	1.125	0.375	2.750	3.500	1.375	2.875	4.625
2	1	5/8	0.438	2.500	1.493	0.250	1.125	0.375	3.250	4.000	1.375	2.875	4.625
2-1/2	1	5/8	0.438	3.000	1.868	0.375	1.125	0.375	3.750	4.500	1.375	3.000	4.750
3-1/4	1	1	0.563	3.750	2.368	0.500	1.250	0.500	4.750	5.750	1.875	3.250	5.625
4	1	1	0.563	4.500	2.743	0.500	1.250	0.500	5.500	6.500	1.875	3.250	5.625

B

Tie Rod Cylinders
 Actuator Products

3MA
 Series

4MA/4ML
 Series

3MAJ/4MAJ
 Series

4MNR
 Series

P1D
 Series



Cap Fixed Clevis

Style BB
 (NFPA MP1)

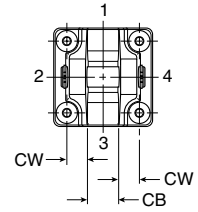
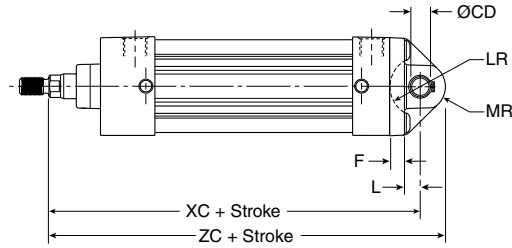
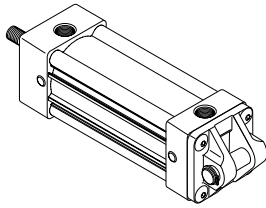

Cap Detachable Clevis

Style BC
 (NFPA MP2)

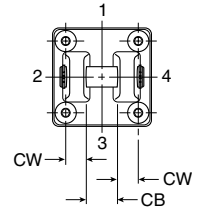
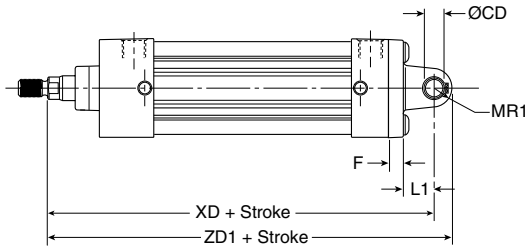
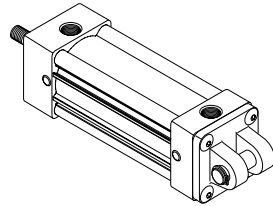

Cap Detachable Eye*

Style BE
 (NFPA MP4)

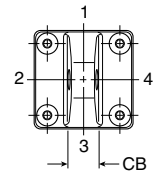
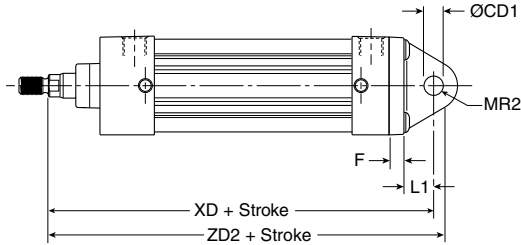
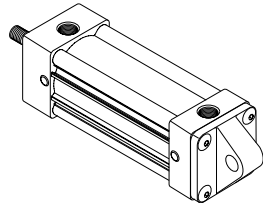

Note: 5 inch bore not available on BE mount, see 4MA series.

Note: For maximum swivel angle of BB mount with rear mounting plate, please reference Catalog 0900P-E, cylinder accessories on page B108.

Styles BB, BC and BE

Bore size	Rod no.	Rod dia. MM	CB	+0.00 CD	+0.002 -0.002 CD1	CW	E	F	L	LR	L1	MR	MR1	MR2	Add stroke				
															XC	XD	ZC	ZD1	ZD2
1-1/2	1	5/8	0.750	0.501	0.500	0.500	2.000	0.375	0.375	0.750	0.750	0.625	0.500	0.625	5.375	5.750	6.000	6.250	6.375
2	1	5/8	0.750	0.501	0.500	0.500	2.500	0.375	0.375	0.750	0.750	0.625	0.500	0.625	5.375	5.750	6.000	6.250	6.375
2-1/2	1	5/8	0.750	0.501	0.500	0.500	3.000	0.375	0.375	0.750	0.750	0.625	0.500	0.688	5.500	5.875	6.125	6.375	6.563
3-1/4	1	1	1.250	0.751	0.750	0.625	3.750	0.625	0.625	1.000	1.250	0.938	0.750	0.875	6.875	7.500	7.813	8.250	8.375
4	1	1	1.250	0.751	0.750	0.625	4.500	0.625	0.625	1.000	1.250	0.938	0.750	0.875	6.875	7.500	7.813	8.250	8.375
5*	1	1	1.250	0.751	0.750	0.625	5.500	0.625	0.625	1.000	1.250	0.938	0.750	0.875	7.125	7.750	8.063	8.500	8.625

* 5 inch bore not available on BE mount, see 4MA series

B
 Tie Rod Cylinders
 Actuator Products
 Series
 3MA
 Series
 4MA/4ML
 Series
 3MAJ/4MAJ
 Series
 4MNR
 Series
 P1D



Intermediate Trunnion

Style DD
 (NFPA MT4)

Note: Tie rod nuts for Style DD have a slot instead of internal hex.

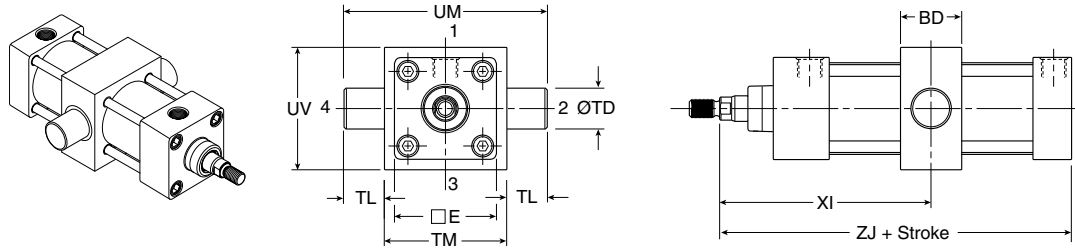

Style DD

Bore size	Rod no.	Rod dia. MM	E	BD	+0.000 -0.001 TD	TL	TM	UM	UT	UV	XG	Min. XI	Add stroke	
													XJ	ZJ
1-1/2	1	5/8	2.000	1.250	1.000	1.000	2.500	4.500	4.000	2.500	1.750	3.036	4.125	4.625
2	1	5/8	2.500	1.500	1.000	1.000	3.000	5.000	4.500	3.000	1.750	3.125	4.125	4.625
2-1/2	1	5/8	3.000	1.500	1.000	1.000	3.500	5.500	5.000	3.500	1.750	3.094	4.250	4.750
3-1/4	1	1	3.750	2.000	1.000	1.000	4.500	6.500	5.750	4.250	2.250	3.969	5.000	5.625
4	1	1	4.500	2.000	1.000	1.000	5.250	7.250	6.500	5.000	2.250	3.969	5.000	5.625
5	1	1	5.500	2.000	1.000	1.000	6.250	8.250	7.500	6.000	2.250	3.969	5.250	5.875

Mounting Kits and Accessories

Refer to page B37 for 3MA mounting kits and cylinder accessories.

1-1/2" - 5" Bore 3MA Piston Seal Kits & Complete Cylinder Kits

Bore size	Rod no.	Rod dia. MM	PK - Piston Seal Kit, Standard Lipseals Includes piston & end seals	SK - Complete Cylinder Kit. Includes wiper, rod seal, rod bearing, cylinder seals, and needle valve inserts	Torque units endcap fastener or tie rod	
			Nitrile seal kit number	Nitrile seal kit number	USA inch-lbs	Metric N-m
1-1/2	1	5/8	PK1503MA01	SK15003MA1	32 - 36	3.6 - 4.1
2	1	5/8	PK2003MA01	SK20003MA1	72 - 82	8 - 9
2-1/2	1	5/8	PK2503MA01	SK25003MA1	72 - 82	8 - 9
3-1/4	1	1	PK3253MA01	SK32003MA1	216 - 228	24 - 25.3
4	1	1	PK4003MA01	SK40003MA1	216 - 228	24 - 25.3
5	1	1	PK5003MA01	SK50003MA1	360 - 372	41 - 42

B
 Tie Rod Cylinders
 Actuator Products
 3MA Series
 4MA/4ML Series
 3MAJ/4MAJ Series
 4MNR Series
 P1D Series



4MA/4ML Series – 1-1/2" thru 5" Bore Size

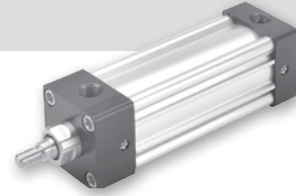

- Industry leading aluminum NFPA interchangeable cylinder with flexible construction
- Bore sizes – 1-1/2", 2", 2-1/2", 3-1/4", 4" and 5"
- Removable bronze alloy gland/bearing for easy maintenance
- Available in any practical stroke length
- 20 standard mounting styles available
- Extruded-profile aluminum body with integrated switch grooves
- Single rod end or double rod ends
- Cushions – standard and adjustable at both ends, optional non-cushioned
- RoHS compliant

Operating information

	4MA	4ML
Operating pressure:	250 PSIG (17 bar) maximum air service	400 PSIG (27 bar) maximum hydraulic service
Temperature range –		
Standard seals	-10°F to 165°F (-23°C to 74°C)	
Fluorocarbon seals	-10°F to 250°F (-23°C to 121°C)	
Low temperature seals	-50°F to 150°F (-46°C to 66°C)	
Filtration requirements:	40 micron, dry filtered air	Filtered hydraulic oil

Ordering information

2.00	J	4MA	U	1	4	A	6.000
Bore size 1.50 ¹ 2.00 2.50 3.25 4.00 5.00	Double rod cylinder ¹² Specify "K" only if double rod cylinder is required.	Series 4MA Air service 4ML Hydraulic service ²	Ports U NPTF R BSPP B BSPT T SAE	Piston rod number Specify rod code number for required diameter. ^{8, 2}	Special modification Specify "S" only for special modification other than rod end, and then describe modification in item notes. (Includes 4MA with Linear Position Sensor Option) ⁷	Cushion cap end Blank Non-cushioned cap end C Cushioned cap end (not available for 4ML)	Stroke length Specify stroke length required in inches. ¹¹
Mounting style Specify mounting style code (see table on following page).	Cushion head end Blank Non-cushioned head end C Cushioned head end (not available for 1.50" bore with 1" rod or 4ML)	Cylinder construction Blank* Standard (extruded body, standard round lobe orientation) A* Extruded body, round lobe orientation rotated 90 degrees from standard N* Extruded body, round lobe orientation rotated 180 degrees from standard Z* Extruded body, round lobe orientation rotated 270 degrees from standard T Aluminum round tube and carbon steel tie rods & nuts	Seals Blank Standard (nitrile seals) V Fluorocarbon seals ⁴ E Fluorocarbon rod wiper and rod seal only ⁵ 4 Low temperature seals ⁴ M Metallic rod wiper, nitrile seals ⁶	Piston rod thread style 4 Small male 8 Intermediate male 9 Short female 55 For use with split coupler ⁹ 3 Special (and specify all dimensions required)	Piston rod thread type A Standard (UNF unified thread) W BSF British fine M* Metric	Rod material and gland code Blank Standard rod and gland H Standard rod and HI LOAD gland Y 17-4 PH stainless steel rod and standard gland Z 17-4 PH stainless steel rod and HI LOAD gland J 303 stainless steel rod and standard gland ¹⁰ K 303 stainless steel rod and HI LOAD gland ¹⁰ S 316 stainless steel rod and standard gland ¹⁰ T 316 stainless steel rod and HI LOAD gland ¹⁰	
Piston type ² Blank Standard (lipseals and magnetic ring) ¹² 1 Lipseals, no magnetic ring ¹² 2 Lipseals, no magnetic ring (aluminum piston) 3 Lipseals and magnetic ring (aluminum piston) (standard for 4ML) 4 Bumper seals, no magnetic ring 6 Bumper seals and magnetic ring B Lipseals, 1/4" thick bumpers both ends ³ H Lipseals, 1/4" thick bumper head end ³ C Lipseals, 1/4" thick bumper cap end ³ D Lipseals and magnetic ring, 1/4" thick bumpers both ends ³ F Lipseals and magnetic ring, 1/4" thick bumper head end ³ R Lipseals and magnetic ring, 1/4" thick bumper cap end ³	<p>* Please reference catalog 0900P-E, table on page B10. Only applies to 1-1/2" to 4" bore size.</p> <p>¹ Not available with Linear Position Sensor Option (LPSO).</p> <p>² Piston Types (blank), 1, 4 and 6 not available for 4ML. Piston Types (blank) and 1 not available for oversize rod numbers 2 and 3. Seals option V only available with Piston Types 2 and 4. Seals option 4 only available with Piston Types 2 and 3.</p> <p>³ Addition of 1/4" bumper results in a 1/4" stroke loss per bumper, per end. For example, a 6" stroke cylinder with 1/4" bumpers at both ends (option B) has an effective stroke of 5-1/2".</p> <p>⁴ Reed and solid-state sensors only available with standard seals or options E and M. See footnote 2.</p> <p>⁵ Used for external chemical compatibility applications, not high temperature.</p> <p>⁶ If fluorocarbon seals are required with this option, please place an "S" for special in the Special Modification field and specify the "fluorocarbon seals and metallic rod wiper" in the item notes.</p> <p>⁷ For Linear Position Sensor Option (LPSO), please include the following information for the Special Modification item notes: a. Sensor part number (please reference catalog 0900P-E, pages B100-B104)</p> <p>b. Sensor position c. Port position (if other than position 1) d. Length of stop tubing, gross stroke and net stroke (if required)</p> <p>⁸ Also, Piston Type option (blank), 3, 6, D, F or R is required.</p> <p>⁹ Review Piston Rod Selection Chart, please reference catalog 0900P-E, page A14 to determine proper piston rod diameter.</p> <p>¹⁰ For additional information regarding this style, please reference catalog 0900P-E, page B105. If non-standard Rod Material and Gland Code is required with this option, please place an "S" for special in Special Modification field and specify Rod Material and Gland Code in the item notes.</p> <p>¹¹ Not available for 4ML.</p> <p>¹² If a stop tube is required, specify gross stroke (net stroke + stop tube) in the model number, then place an "S" for special in the Special Modification field and specify the stop tube length in the item notes. Not available with Piston Types (blank) and 1.</p> <p>¹³ Double rod cylinders not available with composite piston type.</p>						

For ordering purposes, when special options or common modifications are requested, the factory will assign a sequential part number in place of the model number.



B
 Tie Rod Cylinders
 Actuator Products
 3MA Series
 4MA/4ML Series
 3MAJ/4MAJ Series
 4MNR Series
 P1D Series

4MA/4ML Mounting Styles for 1-1/2" to 5" Bore

Mounting style	NFPA mounting	Description	Bore size	Mounting style	NFPA mounting	Description	Bore size
TEF	MX5/MS4	Sleeve Nut with Side Tap (standard mount)	1-1/2 - 5*	CB	MS1	Side End Angle	1-1/2 - 5
T	MX0	No Mount (same construction as TEF)	1-1/2 - 5	G	MS7	Side End Lug	1-1/2 - 4*
TE	MX5	Sleeve Nut (same construction as TEF)	1-1/2 - 5	NB	N/A	Base Bar	1-1/2 - 4*
F	MS4	Side Tap (same construction as TEF)	1-1/2 - 5*	BB	MP1	Cap Fixed Clevis	1-1/2 - 5
J	MF1	Head Rectangular Flange	1-1/2 - 5	BC	MP2	Cap Detachable Clevis	1-1/2 - 5
H	MF2	Cap Rectangular Flange	1-1/2 - 5	BE	MP4	Cap Detachable Eye	1-1/2 - 5
TB	MX3	Tie Rods Extended Head End	1-1/2 - 5	D	MT1	Head Trunnion	1-1/2 - 5*
TC	MX2	Tie Rods Extended Cap End	1-1/2 - 5	DB	MT2	Cap Trunnion	1-1/2 - 5
TD	MX1	Tie Rods Extended Both Ends	1-1/2 - 5	DD	MT4	Intermediate Trunnion	1-1/2 - 5
C	MS2	Side Lug	1-1/2 - 5	KTEF †	MDX5/MDS4	Double Rod End, TEF Mount	1-1/2 - 5

B

Tie Rod Cylinders
Actuator Products

3MA Series

4MA/4ML Series

3MAJ/4MAJ Series

4MNR Series

P1D Series

* Not available for 1-1/2" bore with 1" rod.

† Double rod end cylinders can be ordered with head mountings, i.e. KJ.

Sensors

For sensors see page B339.



Kits & Accessories

See page B37.



Single Rod Dimensioned Drawings (Styles TEF, T, TE and F)

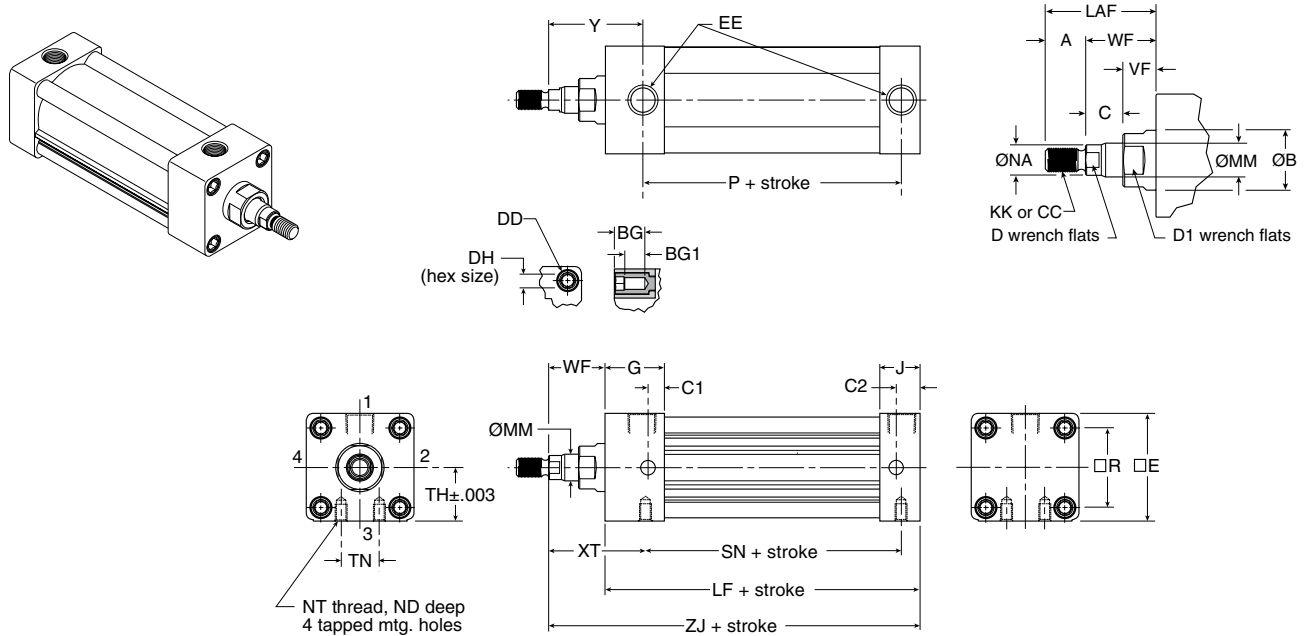

Styles TEF, T, TE and F

Bore size	Rod no.	Rod dia. MM	Thread		Style 8		Style 4 & 9		+0.000 -0.002										EE (NPTF)		G													
			CC	KK	A	AA	B	BG	BG1	C	C1	C2	D	D1	DD	DH	E																	
1-1/2	1*	5/8	1/2-20	7/16-20	0.750	2.020	1.124	0.562	0.374	0.385	1.000	0.500	1/2	1	1/4-28	1/4	2.000	3/8	1.438															
	2	1	7/8-14	3/4-16	1.125	2.020	1.499	0.562	0.374	0.510	-	0.500	7/8	1-3/8	1/4-28	1/4	2.000	3/8	1.438															
2	1	5/8	1/2-20	7/16-20	0.750	2.600	1.124	0.562	0.362	0.385	1.000	0.562	1/2	1	5/16-24	5/16	2.500	3/8	1.375															
	3	1	7/8-14	3/4-16	1.125	2.600	1.499	0.562	0.362	0.510	1.000	0.562	7/8	1-3/8	5/16-24	5/16	2.500	3/8	1.375															
2-1/2	1	5/8	1/2-20	7/16-20	0.750	3.100	1.124	0.562	0.362	0.385	1.000	0.594	1/2	1	5/16-24	5/16	3.000	3/8	1.344															
	3	1	7/8-14	3/4-16	1.125	3.100	1.499	0.562	0.362	0.510	1.000	0.594	7/8	1-3/8	5/16-24	5/16	3.000	3/8	1.344															
3-1/4	1	1	7/8-14	3/4-16	1.125	3.900	1.499	0.700	0.500	0.510	1.188	0.719	7/8	1-3/8	3/8-24	3/8	3.750	1/2	1.594															
	3	1-3/8	1-1/4-12	1-14	1.625	3.900	1.999	0.700	0.500	0.635	1.188	0.719	1-1/8	1-7/8	3/8-24	3/8	3.750	1/2	1.594															
4	1	1	7/8-14	3/4-16	1.125	4.700	1.499	0.700	0.500	0.510	1.188	0.719	7/8	1-3/8	3/8-24	3/8	4.500	1/2	1.594															
	3	1-3/8	1-1/4-12	1-14	1.625	4.700	1.999	0.700	0.500	0.635	1.188	0.719	1-1/8	1-7/8	3/8-24	3/8	4.500	1/2	1.594															
5	1	1	7/8-14	3/4-16	1.125	5.800	1.499	0.781	0.531	0.510	1.188	0.813	7/8	1-3/8	1/2-20	1/2	5.500	1/2	1.594															
	3	1-3/8	1-1/4-12	1-14	1.625	5.800	1.999	0.781	0.531	0.635	1.188	0.813	1-1/8	1-7/8	1/2-20	1/2	5.500	1/2	1.594															
Bore size	Rod no.	Rod dia. MM	J		LAF		NA		ND		NT		R		TH		TN		VF		WF		XT		Y		LF		P		SN		ZJ	
			J	LAF	NA	ND	NT	R	TH	TN	VF	WF	XT	Y	LF	P	SN	ZJ																
1-1/2	1*	5/8	0.938	1.750	0.563	0.375	1/4-20	1.430	0.993	0.625	0.615	1.000	1.938	1.875	3.625	2.313	2.250	4.625																
	2	1	0.938	2.500	0.938	-	-	1.430	0.993	-	0.865	1.375	-	2.250	3.625	2.313	-	5.000																
2	1	5/8	0.937	1.750	0.563	0.438	5/16-18	1.840	1.243	0.875	0.615	1.000	1.938	1.875	3.625	2.313	2.250	4.625																
	3	1	0.937	2.500	0.938	0.375	5/16-18	1.840	1.243	0.875	0.865	1.375	2.313	2.250	3.625	2.313	2.250	5.000																
2-1/2	1	5/8	0.938	1.750	0.563	0.625	3/8-16	2.190	1.493	1.250	0.615	1.000	1.938	1.938	3.750	2.375	2.375	4.750																
	3	1	0.938	2.500	0.938	0.625	3/8-16	2.190	1.493	1.250	0.865	1.375	2.313	2.313	3.750	2.375	2.375	5.125																
3-1/4	1	1	1.125	2.500	0.938	0.750	1/2-13	2.760	1.868	1.500	0.865	1.375	2.438	2.438	4.250	2.625	2.625	5.625																
	3	1-3/8	1.125	3.250	1.313	0.750	1/2-13	2.760	1.868	1.500	0.990	1.625	2.688	2.688	4.250	2.625	2.625	5.875																
4	1	1	1.125	2.500	0.938	0.750	1/2-13	3.320	2.243	2.063	0.865	1.375	2.438	2.438	4.250	2.625	2.625	5.625																
	3	1-3/8	1.125	3.250	1.313	0.750	1/2-13	3.320	2.243	2.063	0.990	1.625	2.688	2.688	4.250	2.625	2.625	5.875																
5	1	1	1.219	2.500	0.938	0.938	5/8-11	4.100	2.743	2.688	0.865	1.375	2.438	2.438	4.500	2.875	2.875	5.875																
	3	1-3/8	1.219	3.250	1.313	0.938	5/8-11	4.100	2.743	2.688	0.990	1.625	2.688	2.688	4.500	2.875	2.875	6.125																

* NOTE - 1-1/2" bore with 1" rod is TE mount, F mount not available.
 1-1/2" bore with 1" rod cannot have a cushion at head end.



4MA Rod End Dimensions

Thread Style 4
 (NFPA Style SM)
 Small Male

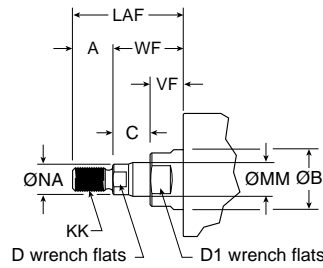

Thread Style 8
 (NFPA Style IM)
 Intermediate Male

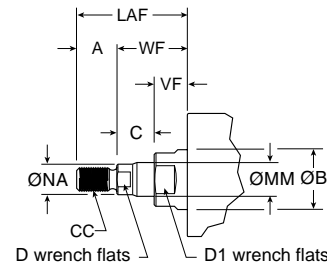

Thread Style 9
 (NFPA Style SF)
 Short Female

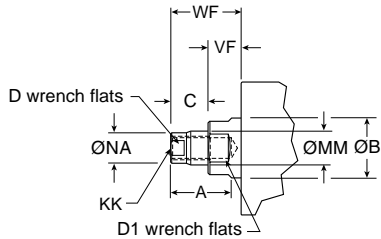

Thread Style 55

For use with Split Coupler
 (please reference catalog 0900P-E, page B105 for more information)

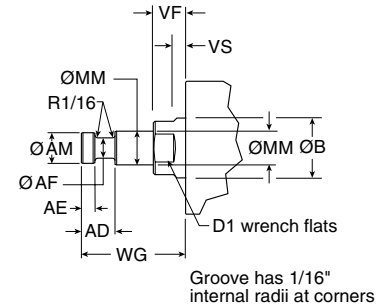

Thread Style 3 - "Special Thread"

Special threads, rod extensions, rod eyes, blanks, etc. are also available.
 To order, specify "Style 3" and give desired dimensions for KK or CC, A and W or WF.
 If otherwise special, please supply dimensioned sketch.

Rod End Dimensions

Bore size	Rod no.	Rod dia. MM	Thread		+0.000 -0.002													
			Style 8 CC	Style 4 & 9 KK	A	AD	AE	AF	AM	B	C	D	D1	LAF	NA	VF	WF	WG
1-1/2	1	5/8	1/2-20	7/16-20	0.750	0.625	0.250	0.375	0.570	1.124	0.385	1/2	1	1.750	0.563	0.615	1.000	1.750
	2	1	7/8-14	3/4-16	1.125	0.938	0.375	0.688	0.950	1.499	0.510	7/8	1-3/8	2.500	0.938	0.865	1.375	2.375
2	1	5/8	1/2-20	7/16-20	0.750	0.625	0.250	0.375	0.570	1.124	0.385	1/2	1	1.750	0.563	0.615	1.000	1.750
	3	1	7/8-14	3/4-16	1.125	0.938	0.375	0.688	0.950	1.499	0.510	7/8	1-3/8	2.500	0.938	0.865	1.375	2.375
2-1/2	1	5/8	1/2-20	7/16-20	0.750	0.625	0.250	0.375	0.570	1.124	0.385	1/2	1	1.750	0.563	0.615	1.000	1.750
	3	1	7/8-14	3/4-16	1.125	0.938	0.375	0.688	0.950	1.499	0.510	7/8	1-3/8	2.500	0.938	0.865	1.375	2.375
3-1/4	1	1	7/8-14	3/4-16	1.125	0.938	0.375	0.688	0.950	1.499	0.510	7/8	1-3/8	2.500	0.938	0.865	1.375	2.375
	3	1-3/8	1-1/4-12	1-14	1.625	1.063	0.375	0.875	1.320	1.999	0.635	1-1/8	1-7/8	3.250	1.313	0.990	1.625	2.750
4	1	1	7/8-14	3/4-16	1.125	0.938	0.375	0.688	0.950	1.499	0.510	7/8	1-3/8	2.500	0.938	0.865	1.375	2.375
	3	1-3/8	1-1/4-12	1-14	1.625	1.063	0.375	0.875	1.320	1.999	0.635	1-1/8	1-7/8	3.250	1.313	0.990	1.625	2.750
5	1	1	7/8-14	3/4-16	1.125	0.938	0.375	0.688	0.950	1.499	0.510	7/8	1-3/8	2.500	0.938	0.865	1.375	2.375
	3	1-3/8	1-1/4-12	1-14	1.625	1.063	0.375	0.875	1.320	1.999	0.635	1-1/8	1-7/8	3.250	1.313	0.990	1.625	2.750

B

Tie Rod Cylinders
Actuator Products

3MA Series

4MA/4ML Series

3MAJ/4MAJ Series

4MNR Series

P1D Series

Head Rectangular Flange

Style J
 (NFPA MF1)

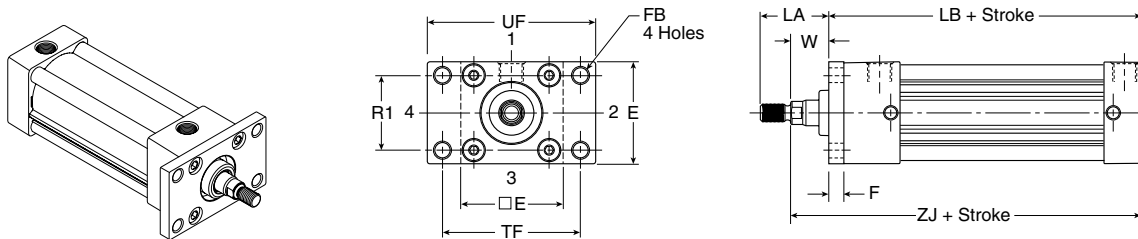

Note: Style J has a W dimension instead of WF and a LA dimension instead of LAF because of the flange installation. Please use dimensions W and LA regarding rod ends only for Style J.
 For reference, $WF = W + F$ and $LA = W + A$.

Cap Rectangular Flange

Style H
 (NFPA MF2)

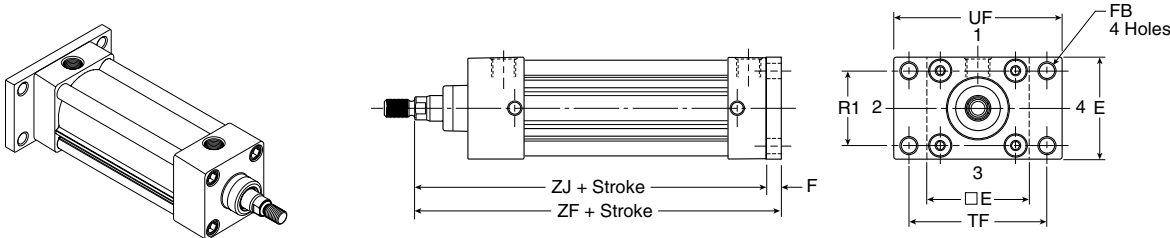

Styles J and H

Bore size	Rod no.	Rod dia. MM	A	E	F	FB	LA	R1	TF	UF	W	Add stroke		
												LB	ZF	ZJ
1-1/2	1	5/8	0.750	2.000	0.375	0.313	1.375	1.430	2.750	3.375	0.625	4.000	5.000	4.625
	2	1	1.125	2.000	0.375	0.313	2.125	1.430	2.750	3.375	1.000	4.000	5.375	5.000
2	1	5/8	0.750	2.500	0.375	0.375	1.375	1.840	3.375	4.125	0.625	4.000	5.000	4.625
	3	1	1.125	2.500	0.375	0.375	2.125	1.840	3.375	4.125	1.000	4.000	5.375	5.000
2-1/2	1	5/8	0.750	3.000	0.375	0.375	1.375	2.190	3.875	4.625	0.625	4.125	5.125	4.750
	3	1	1.125	3.000	0.375	0.375	2.125	2.190	3.875	4.625	1.000	4.125	5.500	5.125
3-1/4	1	1	1.125	3.750	0.625	0.438	1.875	2.760	4.688	5.500	0.750	4.875	6.250	5.625
	3	1-3/8	1.625	3.750	0.625	0.438	2.625	2.760	4.688	5.500	1.000	4.875	6.500	5.875
4	1	1	1.125	4.500	0.625	0.438	1.875	3.320	5.438	6.250	0.750	4.875	6.250	5.625
	3	1-3/8	1.625	4.500	0.625	0.438	2.625	3.320	5.438	6.250	1.000	4.875	6.500	5.875
5	1	1	1.125	5.500	0.625	0.563	1.875	4.100	6.625	7.625	0.750	5.125	6.500	5.875
	3	1-3/8	1.625	5.500	0.625	0.563	2.625	4.100	6.625	7.625	1.000	5.125	6.750	6.125

B
 Tie Rod Cylinders
 Actuator Products
 Series
 3MA
 Series
 4MA/4ML
 Series
 3MAJ/4MAJ
 Series
 4MNR
 Series
 P1D



Tie Rods Ext. Head End

Style TB
(NFPA MX3)

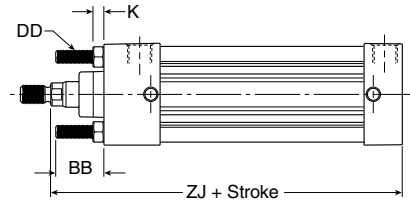
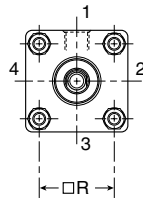
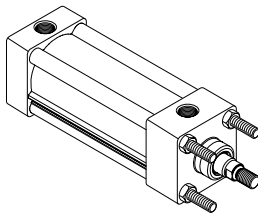

Tie Rods Ext. Cap End

Style TC
(NFPA MX2)

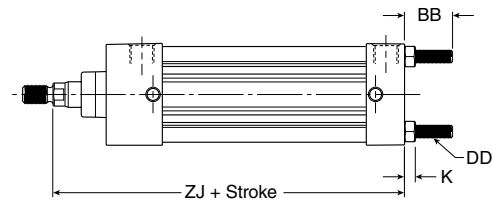
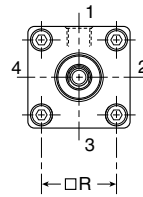
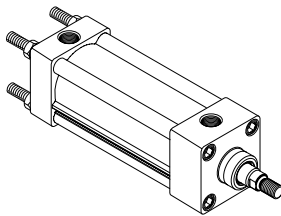

Tie Rods Ext. Both Ends

Style TD
(NFPA MX1)

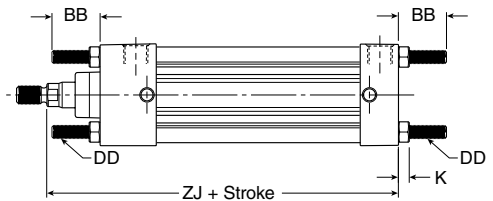
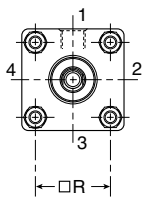
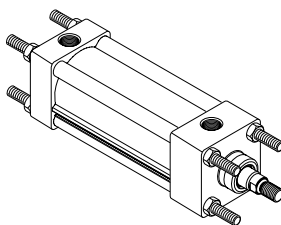

Styles TB, TC and TD

Bore size	Rod no.	Rod dia. MM	BB	DD	E	K	R	Add stroke	
								ZJ	
1-1/2	1	5/8	1.000	1/4-28	2.000	0.250	1.430	4.625	
	2	1	1.000	1/4-28	2.000	0.250	1.430	5.000	
2	1	5/8	1.125	5/16-24	2.500	0.313	1.840	4.625	
	3	1	1.125	5/16-24	2.500	0.313	1.840	5.000	
2-1/2	1	5/8	1.125	5/16-24	3.000	0.313	2.190	4.750	
	3	1	1.125	5/16-24	3.000	0.313	2.190	5.125	
3-1/4	1	1	1.375	3/8-24	3.750	0.375	2.760	5.625	
	3	1-3/8	1.375	3/8-24	3.750	0.375	2.760	5.875	
4	1	1	1.375	3/8-24	4.500	0.375	3.320	5.625	
	3	1-3/8	1.375	3/8-24	4.500	0.375	3.320	5.875	
5	1	1	1.813	1/2-20	5.500	0.438	4.100	5.875	
	3	1-3/8	1.813	1/2-20	5.500	0.438	4.100	6.125	

B

Tie Rod Cylinders
Actuator Products

3MA Series

4MA/4ML Series

3MAJ/4MAJ Series

4MNR Series

P1D Series

Side Lug
 Style C for
 (NFPA MS2)

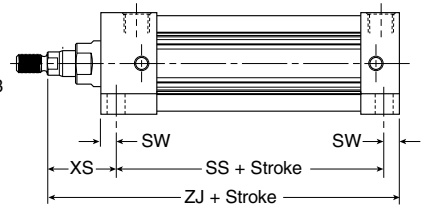
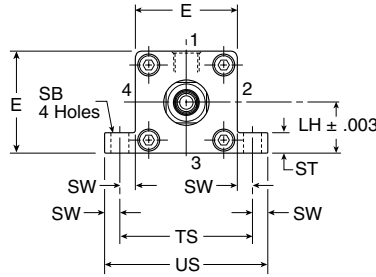
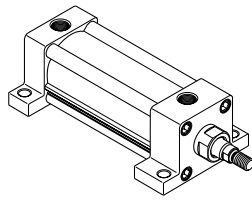

Styles C

Bore size	Rod no.	Rod dia. MM	E	LH	SB	ST	ST1	ST2	SW	SW1	TS	US	XS	Add stroke	
														SS	ZJ
1-1/2	1	5/8	2.000	0.993	0.438	0.500	1.000	0.120	0.375	0.495	2.750	3.500	1.375	2.875	4.625
	2	1	2.000	0.993	0.438	0.500	1.000	0.120	0.375	0.495	2.750	3.500	1.750	2.875	5.000
2	1	5/8	2.500	1.243	0.438	0.500	1.250	0.120	0.375	0.495	3.250	4.000	1.375	2.875	4.625
	3	1	2.500	1.243	0.438	0.500	1.250	0.120	0.375	0.495	3.250	4.000	1.750	2.875	5.000
2-1/2	1	5/8	3.000	1.493	0.438	0.500	1.343	0.120	0.375	0.495	3.750	4.500	1.375	3.000	4.750
	3	1	3.000	1.493	0.438	0.500	1.343	0.120	0.375	0.495	3.750	4.500	1.750	3.000	5.125
3-1/4	1	1	3.750	1.868	0.563	0.750	1.500	0.188	0.500	0.688	4.750	5.750	1.875	3.250	5.625
	3	1-3/8	3.750	1.868	0.563	0.750	1.500	0.188	0.500	0.688	4.750	5.750	2.125	3.250	5.875
4	1	1	4.500	2.243	0.563	0.750	1.500	0.188	0.500	0.688	5.500	6.500	1.875	3.250	5.625
	3	1-3/8	4.500	2.243	0.563	0.750	1.500	0.188	0.500	0.688	5.500	6.500	2.125	3.250	5.875
5	1	1	5.500	2.743	0.813	1.000	1.500	0.250	0.688	0.938	6.875	8.250	2.063	3.125	5.875
	3	1-3/8	5.500	2.743	0.813	1.000	1.500	0.250	0.688	0.938	6.875	8.250	2.313	3.125	6.125

Side End Angle*

Style CB
 (NFPA MS1)

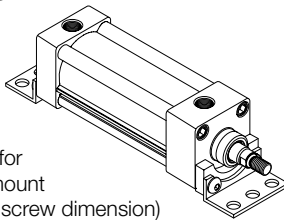

Note:
 Dimension "S" is for the holes in the mount (not the screw to screw dimension)

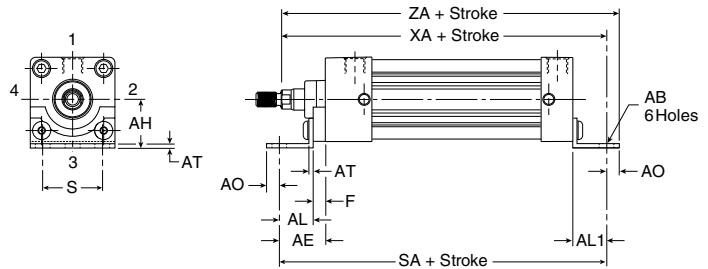

*Maximum recommended pressure for this mount is 150 PSIG

Style CB

Bore size	Rod no.	Rod dia. MM	AB	AE	AH	AL	AL1	AO	AT	E	F	S	Add stroke		
													SA	XA	ZA
1-1/2	1	5/8	0.438	1.375	1.188	1.000	1.000	0.375	0.125	2.000	0.375	1.250	6.000	5.625	6.000
	2	1	0.438	1.375	1.188	1.000	1.000	0.375	0.125	2.000	0.375	1.250	6.000	6.000	6.375
2	1	5/8	0.438	1.375	1.438	1.000	1.000	0.375	0.125	2.500	0.375	1.750	6.000	5.625	6.000
	3	1	0.438	1.375	1.438	1.000	1.000	0.375	0.125	2.500	0.375	1.750	6.000	6.000	6.375
2-1/2	1	5/8	0.438	1.375	1.625	1.000	1.000	0.375	0.125	3.000	0.375	2.250	6.125	5.750	6.125
	3	1	0.438	1.375	1.625	1.000	1.000	0.375	0.125	3.000	0.375	2.250	6.125	6.125	6.500
3-1/4	1	1	0.563	1.875	1.938	1.250	1.250	0.500	0.125	3.750	0.625	2.750	7.375	6.875	7.375
	3	1-3/8	0.563	1.875	1.938	1.250	1.250	0.500	0.125	3.750	0.625	2.750	7.375	7.125	7.625
4	1	1	0.563	-	2.250	1.875	1.250	0.500	0.125	4.500	-	3.500	7.375	6.875	7.375
	3	1-3/8	0.563	-	2.250	1.875	1.250	0.500	0.125	4.500	-	3.500	7.375	7.125	7.625
5	1	1	0.688	2.000	2.750	1.375	1.375	0.625	0.188	5.500	0.625	4.250	7.875	7.250	7.875
	3	1-3/8	0.688	2.000	2.750	1.375	1.375	0.625	0.188	5.500	0.625	4.250	7.875	7.500	8.125



Side End Lug

Style G
(NFPA MS7)

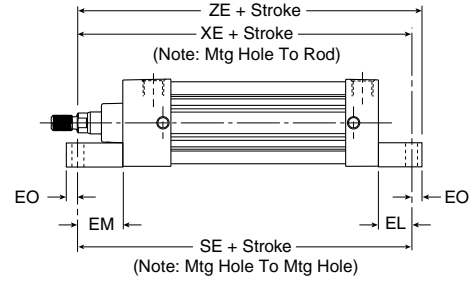
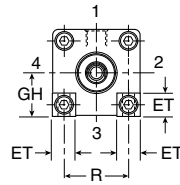
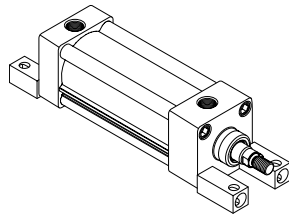

Style G

Bore size	Rod no.	Rod dia. MM	E	EB	EL	EM	EO	ET	GH	R	Add Stroke		
											SE	XE	ZE
1-1/2	1	5/8	2.000	0.281	0.750	1.125	0.250	0.563	0.993	1.430	5.500	5.375	5.625
	2	1	-	-	-	-	-	-	-	-	-	-	-
2	1	5/8	2.500	0.344	0.938	1.313	0.313	0.688	1.243	1.840	5.875	5.563	5.875
	3	1	2.500	0.344	0.938	1.313	0.313	0.688	1.243	1.840	5.875	5.938	6.250
2-1/2	1	5/8	3.000	0.344	1.063	1.438	0.313	0.813	1.493	2.190	6.250	5.813	6.125
	3	1	3.000	0.344	1.063	1.438	0.313	0.813	1.493	2.190	6.250	6.188	6.500
3-1/4	1	1	3.750	0.406	0.875	1.500	0.375	1.000	1.868	2.760	6.625	6.500	6.875
	3	1-3/8	3.750	0.406	0.875	1.500	0.375	1.000	1.868	2.760	6.625	6.750	7.125
4	1	1	4.500	0.406	1.000	1.625	0.375	1.188	2.243	3.320	6.875	6.625	7.000
	3	1-3/8	4.500	0.406	1.000	1.625	0.375	1.188	2.243	3.320	6.875	6.875	7.250

Base Bar Mount

Style NB for 4MA

Note: Fasteners for NB base bar mount have been applied with removable threadlocking compound and torqued to bottom of endcaps.

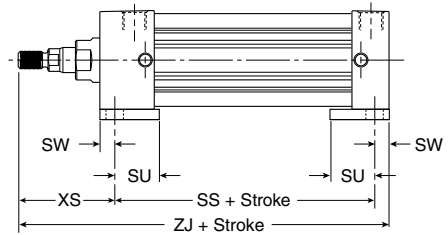
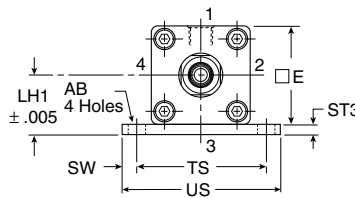
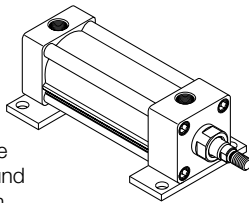

Style NB

Bore size	Rod no.	Rod dia. MM	AB	E	LH1	ST3	SU	SW	TS	US	XS	Add stroke	
												SS	ZJ
1-1/2	1	5/8	0.438	2.000	1.243	0.250	1.125	0.375	2.750	3.500	1.375	2.875	4.625
	2	1	-	-	-	-	-	-	-	-	-	-	-
2	1	5/8	0.438	2.500	1.493	0.250	1.125	0.375	3.250	4.000	1.375	2.875	4.625
	3	1	0.438	2.500	1.493	0.250	1.125	0.375	3.250	4.000	1.750	2.875	5.000
2-1/2	1	5/8	0.438	3.000	1.868	0.375	1.125	0.375	3.750	4.500	1.375	3.000	4.750
	3	1	0.438	3.000	1.868	0.375	1.125	0.375	3.750	4.500	1.750	3.000	5.125
3-1/4	1	1	0.563	3.750	2.368	0.500	1.250	0.500	4.750	5.750	1.875	3.250	5.625
	3	1-3/8	0.563	3.750	2.368	0.500	1.250	0.500	4.750	5.750	2.125	3.250	5.875
4	1	1	0.563	4.500	2.743	0.500	1.250	0.500	5.500	6.500	1.875	3.250	5.625
	3	1-3/8	0.563	4.500	2.743	0.500	1.250	0.500	5.500	6.500	2.125	3.250	5.875

B
 Tie Rod Cylinders
 Actuator Products
 3MA Series
 4MA/4ML Series
 3MAJ/4MAJ Series
 4MNR Series
 P1D Series



Cap Fixed Clevis

Style BB
(NFPA MP1)

Note: For maximum swivel angle of BB mount with rear mounting plate, see cylinder accessories

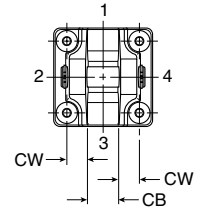
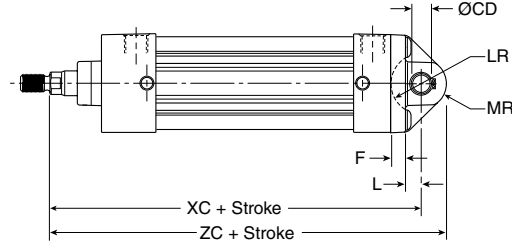
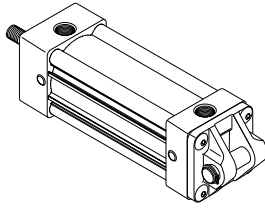

Cap Detachable Clevis

Style BC
(NFPA MP2)

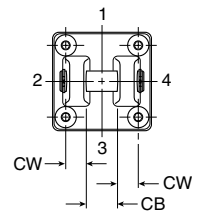
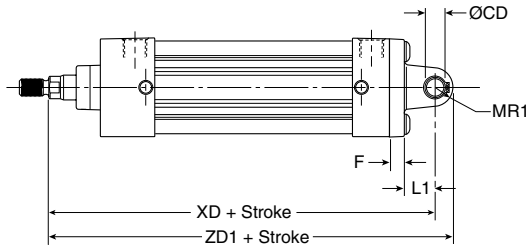
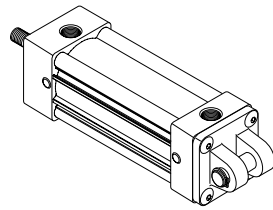

Cap Detachable Eye

Style BE
(NFPA MP4)

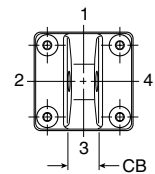
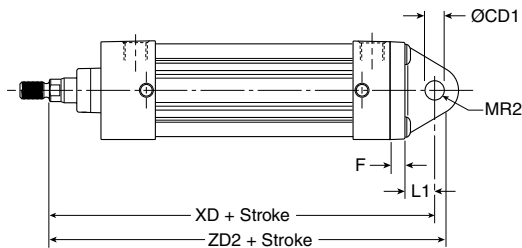
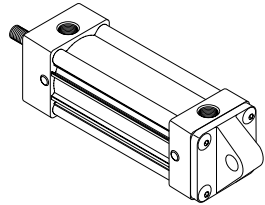

Styles BB, BC and BE

Bore size	Rod no.	Rod dia. MM	CB	Rod dia.		CW	E	F	L	LR	L1	MR	MR1	MR2	Add stroke				
				+0.000 -0.002	+0.002 +0.004										XC	XD	ZC	ZD1	ZD2
1-1/2	1	5/8	0.750	0.501	0.500	0.500	2.000	0.375	0.375	0.750	0.750	0.625	0.500	0.625	5.375	5.750	6.000	6.250	6.375
	2	1	0.750	0.501	0.500	0.500	2.000	0.375	0.375	0.750	0.750	0.625	0.500	0.625	5.750	6.125	6.375	6.625	6.750
	1	5/8	0.750	0.501	0.500	0.500	2.500	0.375	0.375	0.750	0.750	0.625	0.500	0.625	5.375	5.750	6.000	6.250	6.375
2	3	1	0.750	0.501	0.500	0.500	2.500	0.375	0.375	0.750	0.750	0.625	0.500	0.625	5.750	6.125	6.375	6.625	6.750
	1	5/8	0.750	0.501	0.500	0.500	3.000	0.375	0.375	0.750	0.750	0.625	0.500	0.688	5.500	5.875	6.125	6.375	6.563
2-1/2	3	1	0.750	0.501	0.500	0.500	3.000	0.375	0.375	0.750	0.750	0.625	0.500	0.688	5.875	6.250	6.500	6.750	6.313
	1	1	1.250	0.751	0.750	0.625	3.750	0.625	0.625	1.000	1.250	0.938	0.750	0.875	6.875	7.500	7.813	8.250	8.375
3-1/4	3	1-3/8	1.250	0.751	0.750	0.625	3.750	0.625	0.625	1.000	1.250	0.938	0.750	0.875	7.125	7.750	8.063	8.500	8.625
	1	1	1.250	0.751	0.750	0.625	4.500	0.625	0.625	1.000	1.250	0.938	0.750	0.875	6.875	7.500	7.813	8.250	8.375
4	3	1-3/8	1.250	0.751	0.750	0.625	4.500	0.625	0.625	1.000	1.250	0.938	0.750	0.875	7.125	7.750	8.063	8.500	8.625
	1	1	1.250	0.751	0.750	0.625	5.500	0.625	0.625	1.000	1.250	0.938	0.750	0.875	7.125	7.750	8.063	8.500	8.625
5	3	1-3/8	1.250	0.751	0.750	0.625	5.500	0.625	0.625	1.000	1.250	0.938	0.750	0.875	7.375	8.000	8.313	8.750	8.875
	1	1	1.250	0.751	0.750	0.625	5.500	0.625	0.625	1.000	1.250	0.938	0.750	0.875	7.375	8.000	8.313	8.750	8.875



Head Trunnion*

Style D
(NFPA MT1)

Note: not available for 1-1/2" bore with 1" rod.

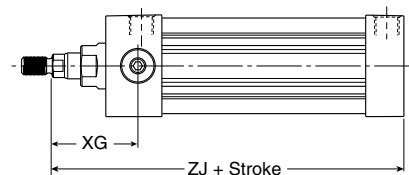
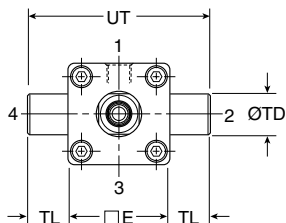
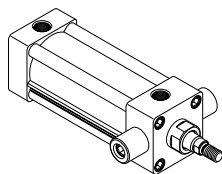

Cap Trunnion

Style DB
(NFPA MT2)

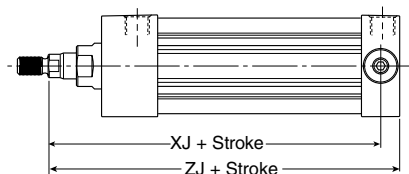
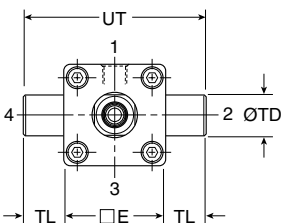
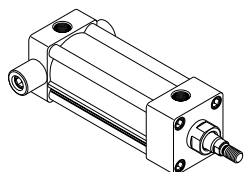

Intermediate Trunnion

Style DD
(NFPA MT4)

Note: Tie rod nuts for Style DD have a slot instead of internal hex.

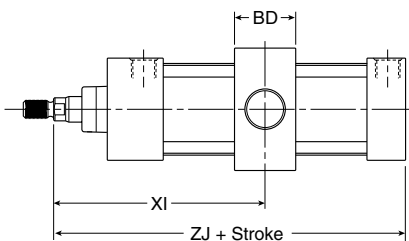
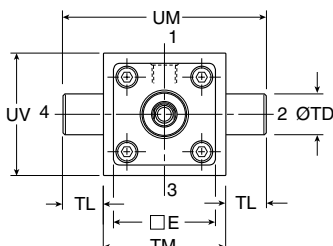
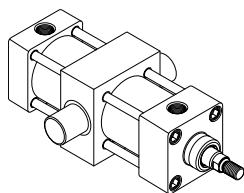

Styles D, DB and DD

Bore size	Rod no.	Rod dia. MM	E	BD	+0.000 -0.001 TD	TL	TM	UM	UT	UV	XG	Min. XI	Add stroke	
													XJ	ZJ
1-1/2	1 *	5/8	2.000	1.250	1.000	1.000	2.500	4.500	4.000	2.500	1.750	3.036	4.125	4.625
	2	1	2.000	1.250	1.000	1.000	2.500	4.500	4.000	2.500	-	3.437	4.250	5.000
2	1	5/8	2.500	1.500	1.000	1.000	3.000	5.000	4.500	3.000	1.750	3.125	4.125	4.625
	3	1	2.500	1.500	1.000	1.000	3.000	5.000	4.500	3.000	2.125	3.500	4.500	5.000
2-1/2	1	5/8	3.000	1.500	1.000	1.000	3.500	5.500	5.000	3.500	1.750	3.094	4.250	4.750
	3	1	3.000	1.500	1.000	1.000	3.500	5.500	5.000	3.500	2.125	3.469	4.625	5.125
3-1/4	1	1	3.750	2.000	1.000	1.000	4.500	6.500	5.750	4.250	2.250	3.969	5.000	5.625
	3	1-3/8	3.750	2.000	1.000	1.000	4.500	6.500	5.750	4.250	2.500	4.219	5.250	5.875
4	1	1	4.500	2.000	1.000	1.000	5.250	7.250	6.500	5.000	2.250	3.969	5.000	5.625
	3	1-3/8	4.500	2.000	1.000	1.000	5.250	7.250	6.500	5.000	2.500	4.219	5.250	5.875
5	1	1	5.500	2.000	1.000	1.000	6.250	8.250	7.500	6.000	2.250	3.969	5.250	5.875
	3	1-3/8	5.500	2.000	1.000	1.000	6.250	8.250	7.500	6.000	2.500	4.219	5.500	6.125

* Head trunnion style D not available for 1-1/2" bore with 1" rod

Kits & Accessories

See page B37.



B

Tie Rod Cylinders
Actuator Products

3MA Series

4MA/4ML Series

3MAJ/4MAJ Series

4MNR Series

P1D Series

4MA/4ML Series – 6" thru 8" Bore Size

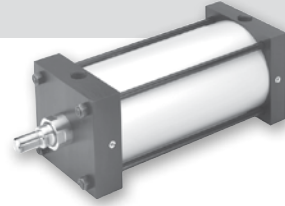

- Industry leading NFPA interchangeable cylinder with flexible construction
- Bore sizes – 6" and 8"
- Removable bronze alloy gland/bearing for easy maintenance
- Available in any practical stroke length
- Tube and tie rod construction for heavy duty use
- Single rod end or double rod ends
- Cushions – optional and adjustable at either end or both ends (N/A for 4ML hydraulic version)
- 20 standard mounting styles available
- RoHS compliant

Operating information

	4MA	4ML
Operating pressure:	250 PSIG (17 bar) maximum air service	400 PSIG (27 bar) maximum hydraulic service
Temperature range –		
Standard seals	-10°F to 165°F (-23°C to 74°C)	
Fluorocarbon seals	-10°F to 250°F (-23°C to 121°C)	
Low temperature seals	-50°F to 150°F (-46°C to 66°C)	
Filtration requirements:	40 micron, dry filtered air Filtered hydraulic oil	

Ordering information

6.00	□	□	J	4MA	□	U	□	□	1	4	□	A	□	12.000
Bore size 6.00 8.00		Double rod cylinder Specify "K" only if double rod cylinder is required.		Series 4MA Air service 4ML Hydraulic service		Ports U NPTF R BSPP B BSPT T SAE			Piston rod number Specify rod code number for required diameter. 8, 2					Stroke length Specify stroke length required in inches. 8
			Mounting style Specify mounting style code (see table on following page).					Special modification Specify "S" only for special modification other than rod end, and then describe modification in item notes. (Includes 4MA with Linear Position Sensor Option) 7				Cushion cap end Blank Non-cushioned cap end C Cushioned cap end (not available for 4ML)		
		Cushion head end Blank Non-cushioned head end C Cushioned head end (not available for 4ML)										Piston rod thread type A Standard (UNF unified thread) W BSF British fine M* Metric		
			Piston type Blank Standard (lipseals and magnetic ring) 3 Lipseals and magnetic ring			Seals Blank Standard (nitrile seals) V Fluorocarbon seals 1 E Fluorocarbon rod wiper and rod seal only 2 4 Low temperature seals 1 M Metallic rod wiper, nitrile seals 3							Rod material and gland code Blank Standard rod and gland H Standard rod and HI LOAD gland Y 17-4 PH stainless steel rod and standard gland Z 17-4 PH stainless steel rod and HI LOAD gland J 303 stainless steel rod and standard gland 7 K 303 stainless steel rod and HI LOAD gland 7 S 316 stainless steel rod and standard gland 7 T 316 stainless steel rod and HI LOAD gland 7	
								Piston rod thread style 4 Small male 8 Intermediate male 9 Short female 55 For use with split coupler 6 3 Special (and specify all dimensions required)						

* Please reference catalog 0900P-E, page B106.

Sensors
 For sensors see page B339.

1 Reed and solid-state sensors only available with standard seals or options E and M.
 2 Used for external chemical compatibility applications, not high temperature.
 3 If fluorocarbon seals are required with this option, please place an "S" for special in the Special Modification field and specify the "fluorocarbon seals and metallic rod wiper" in the item notes.
 4 For Linear Position Sensor Option (LPSO), please include the following information for the Special Modification item notes:
 a. Sensor part number (please reference catalog 0900P-E, pages B100-B104)
 b. Sensor position
 c. Port position (if other than position 1)
 d. Length of stop tubing, gross stroke and net stroke (if required)
 Also, Piston Type 3 is required.
 5 Review Piston Rod Selection Chart, please reference catalog 0900P-E, page A14 to determine proper piston rod diameter.
 6 For additional information regarding this style, please reference catalog 0900P-E, page B105. If non-standard Rod Material and Gland Code is required with this option, please place an "S" for special in Special Modification field and specify Rod Material and Gland Code in the item notes.
 7 Not available for 4ML.
 8 If a stop tube is required, specify gross stroke (net stroke + stop tube) in the model number, then place an "S" for special in the Special Modification field and specify the stop tube length in the item notes.

For ordering purposes, when special options or common modifications are requested, the factory will assign a sequential part number in place of the model number.

4MA/4ML Mounting Styles for 6" to 8" Bore

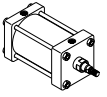
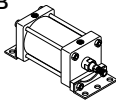
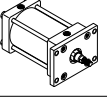
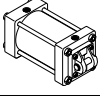
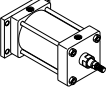
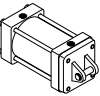
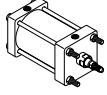
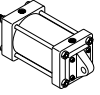
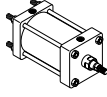
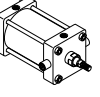
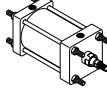
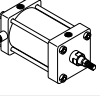
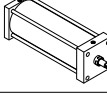
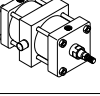
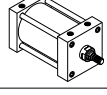
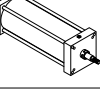
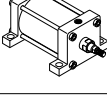
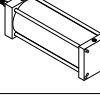
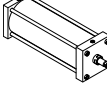
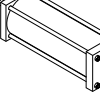
Mounting style	NFPA mounting	Description	Bore size	Mounting style	NFPA mounting	Description	Bore size
T 	MX0	No Mount	6 - 8	CB 	MS1	Side End Angle	6 - 8
J 	MF1	Head Rectangular Flange	6	BB 	MP1	Cap Fixed Clevis	6 - 8
H 	MF2	Cap Rectangular Flange	6	BC 	MP2	Cap Detachable Clevis	6 - 8
TB 	MX3	Tie Rods Extended Head End	6 - 8	BE 	MP4	Cap Detachable Eye	6
TC 	MX2	Tie Rods Extended Cap End	6 - 8	D 	MT1	Head Trunnion	6 - 8
TD 	MX1	Tie Rods Extended Both Ends	6 - 8	DB 	MT2	Cap Trunnion	6 - 8
TE 	MX5	Sleeve Nut	6 - 8	DD 	MT4	Intermediate Trunnion	6 - 8
TEF 	MX5/MS4	Sleeve Nut with Side Tap	6 - 8	JB 	ME3	Head Square	8
C 	MS2	Side Lug	6 - 8	HB 	ME4	Cap Square	8
F 	MS4	Side Tap	6 - 8	KT † 	MDX0	Double Rod End, No Mount	6 - 8

† Double rod end cylinders can be ordered with head mountings, i.e. KJ.

B

Tie Rod Cylinders
Actuator Products

3MA
Series

4MA/4ML
Series

3MAJ/4MAJ
Series

4MNR
Series

P1D
Series

Single Rod Dimensioned Drawings – (Style T)

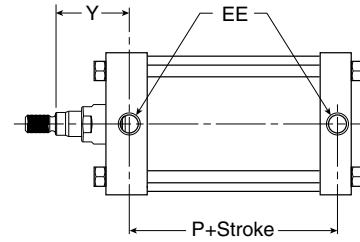
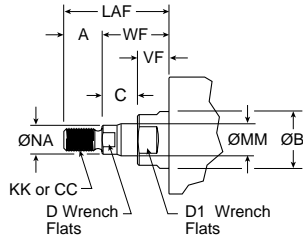
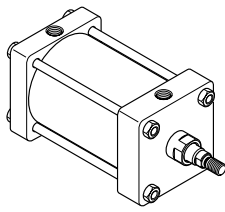

For dimensions of all standard rod end styles, please see next page.

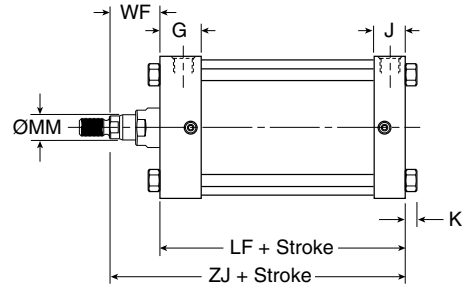
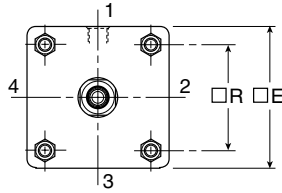

Style T

Bore size	Rod no.	Rod dia. MM	Thread		A	AA	+0.000 -0.002 B	C	D	D1	E	EE (NPTF)	G
			Style 8 CC	Style 4 & 9 KK									
6	1	1-3/8	1-1/4-12	1-14	1.625	6.900	1.999	0.635	1-1/8	1-7/8	6.500	3/4	1.910
	3	1-3/4	1-1/2-12	1-1/4-12	2.000	6.900	2.374	0.760	1-1/2	2-3/16	6.500	3/4	1.910
8	1	1-3/8	1-1/4-12	1-14	1.625	9.100	1.999	0.635	1-1/8	1-7/8	8.500	3/4	1.810
	3	1-3/4	1-1/2-12	1-1/4-12	2.000	9.100	2.374	0.760	1-1/2	2-3/16	8.500	3/4	1.810

Bore size	Rod no.	Rod dia. MM	Add stroke										
			J	K	LAF	NA	R	VF	WF	Y	LF	P	ZJ
6	1	1-3/8	1.410	0.438	3.250	1.313	4.880	0.990	1.625	2.813	5.000	3.125	6.625
	3	1-3/4	1.410	0.438	3.875	1.688	4.880	1.115	1.875	3.063	5.000	3.125	6.875
8	1	1-3/8	1.440	0.563	3.250	1.313	6.440	0.990	1.625	2.750	5.125	3.250	6.750
	3	1-3/4	1.440	0.563	3.875	1.688	6.440	1.115	1.875	3.000	5.125	3.250	7.000

B
Tie Rod Cylinders
Actuator Products

3MA Series

4MA/4ML Series

3MAJ/4MAJ Series

4MNR Series

P1D Series



4MA Rod End Dimensions

Thread Style 4
 (NFPA Style SM)
 Small Male

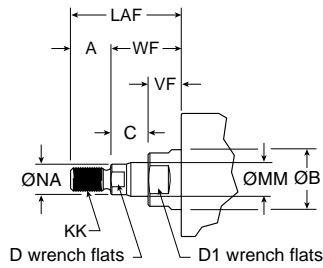

Thread Style 8
 (NFPA Style IM)
 Intermediate Male

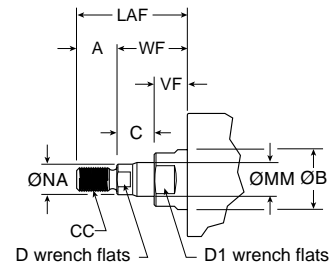

Thread Style 9
 (NFPA Style SF)
 Short Female

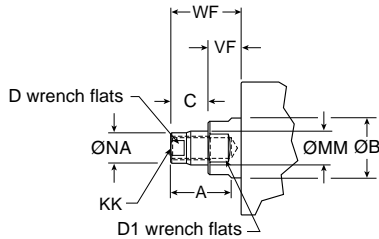

Thread Style 55
 For use with Split Coupler
 (please reference catalog 0900P-E, page B105 for more information)

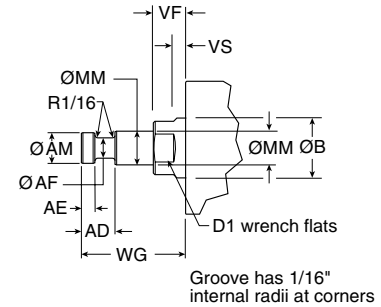

Thread Style 3 - "Special Thread"

Special threads, rod extensions, rod eyes, blanks, etc. are also available.
 To order, specify "Style 3" and give desired dimensions for KK or CC, A and W or WF.
 If otherwise special, please supply dimensioned sketch.

Rod End Dimensions

Bore size	Rod no.	Rod dia. MM	Thread		Tolerances: +.000 / -.002													
			Style 8 CC	Style 4 & 9 KK	A	AD	AE	AF	AM	B	C	D	D1	LAF	NA	VF	WF	WG
6	1	1-3/8	1-1/4-12	1-14	1.625	1.063	0.375	0.875	1.320	1.999	0.635	1-1/8	1-7/8	3.250	1.313	0.990	1.625	2.750
	3	1-3/4	1-1/2-12	1-1/4-12	2.000	1.313	0.500	1.125	1.700	2.374	0.760	1-1/2	2-3/16	3.875	1.688	1.115	1.875	3.125
8	1	1-3/8	1-1/4-12	1-14	1.625	1.063	0.375	0.875	1.320	1.999	0.635	1-1/8	1-7/8	3.250	1.313	0.990	1.625	2.750
	3	1-3/4	1-1/2-12	1-1/4-12	2.000	1.313	0.500	1.125	1.700	2.374	0.760	1-1/2	2-3/16	3.875	1.688	1.115	1.875	3.125

B

Tie Rod Cylinders
Actuator Products

3MA Series

4MA/4ML Series

3MAJ/4MAJ Series

4MNR Series

P1D Series



Head Rectangular Flange

Style J
 (NFPA MF1)
 (only 6" Bore)

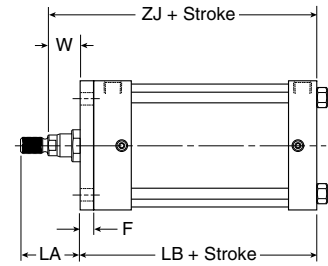
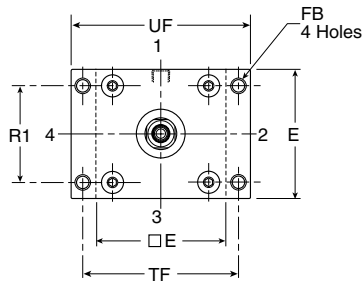
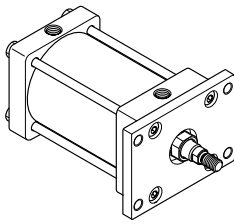

Note: Style J has a W dimension instead of WF and a LA dimension instead of LAF because of the flange installation. Please use dimensions W and LA regarding rod ends only for Style J. For reference, $WF = W + F$ and $LA = W + A$.

Cap Rectangular Flange

Style H
 (NFPA MF2)
 (only 6" Bore)

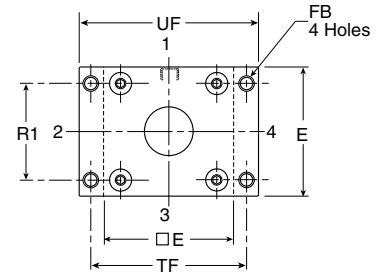
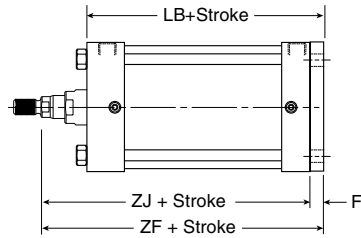
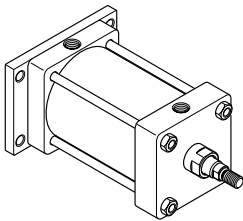

Styles J and H

Bore size	Rod no.	Rod dia. MM	A	E	F	FB	LA	R1	TF	UF	W	Add stroke		
												LB	ZF	ZJ
6	1	1-3/8	1.625	6.500	0.750	0.563	2.500	4.880	7.625	8.625	0.875	5.750	7.375	6.625
	3	1-3/4	2.000	6.500	0.750	0.563	3.125	4.880	7.625	8.625	1.125	5.750	7.625	6.875

B
 Tie Rod Cylinders
 Actuator Products
 Series
 3MA
 Series
 4MA/4ML
 Series
 3MAJ/4MAJ
 Series
 4MNR
 Series
 P1D
 Series



Tie Rods Ext. Head End

Style TB
 (NFPA MX3)

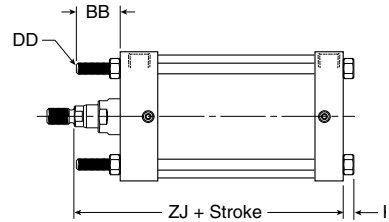
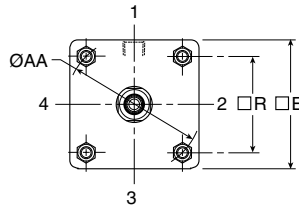
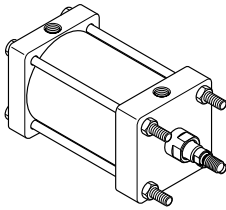

Tie Rods Ext. Cap End

Style TC
 (NFPA MX2)

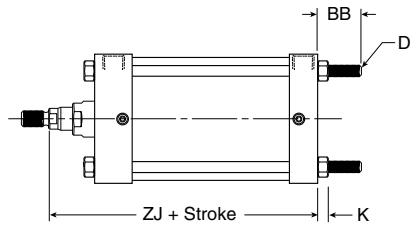
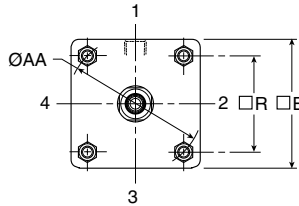
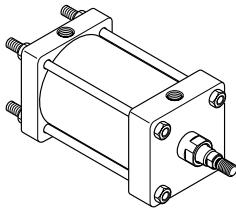

Tie Rods Ext. Both Ends

Style TD
 (NFPA MX1)

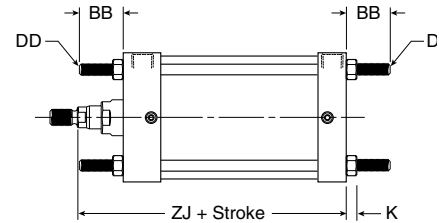
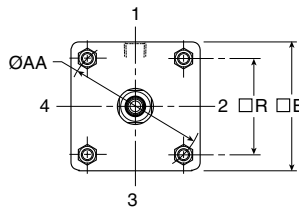
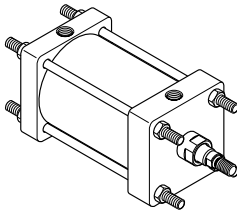

Styles TB, TC and TD

Bore size	Rod no.	Rod dia. MM	AA	BB	DD	E	K	R	Add stroke	
									ZJ	
6	1	1-3/8	6.900	1.813	1/2-20	6.500	0.438	4.880	6.625	
	3	1-3/4	6.900	1.813	1/2-20	6.500	0.438	4.880	6.875	
8	1	1-3/8	9.100	2.313	5/8-18	8.500	0.563	6.440	6.750	
	3	1-3/4	9.100	2.313	5/8-18	8.500	0.563	6.440	7.000	

B

Tie Rod Cylinders
 Actuator Products

3MA
 Series

4MA/4ML
 Series

3MAJ/4MAJ
 Series

4MNR
 Series

P1D
 Series

Sleeve Nut

Style TE
 (NFPA MX5)

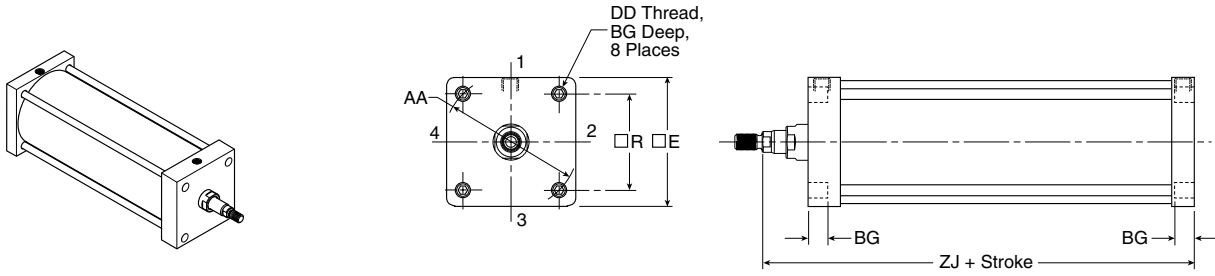

Style TE

Bore size	Rod no.	Rod dia. MM	AA	BG	DD	E	R	Add stroke	
								ZJ	
6	1	1-3/8	6.900	0.500	1/2-20	6.500	4.880	6.625	
	3	1-3/4	6.900	0.500	1/2-20	6.500	4.880	6.875	
8	1	1-3/8	9.100	0.620	5/8-18	8.500	6.440	6.750	
	3	1-3/4	9.100	0.620	5/8-18	8.500	6.440	7.000	

B
Tie Rod Cylinders Actuator Products
3MA Series
4MA/4ML Series
3MAJ/4MAJ Series
4MNR Series
P1D Series

Side End Angle*

Style CB
 (NFPA MS1)

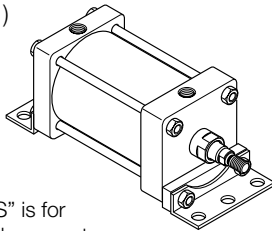

Note:
 Dimension "S" is for the holes in the mount
 (not the screw to screw dimension)

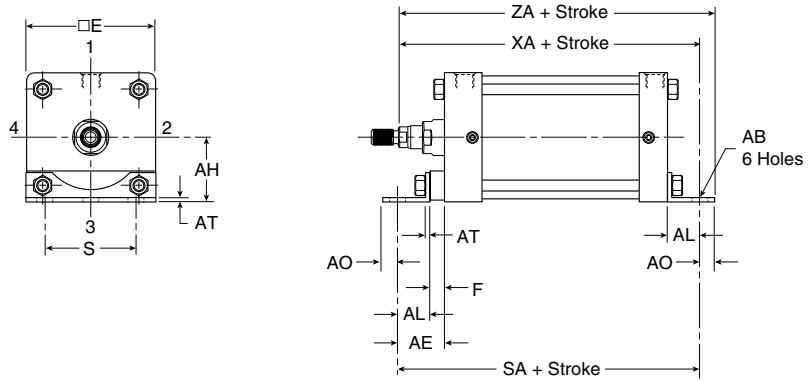

*Maximum recommended pressure for this mount is 150 PSIG

Style CB

Bore size	Rod no.	Rod dia. MM	AB	AE	AH	AL	AO	AT	E	F	S	Add stroke		
												SA	XA	ZA
6	1	1-3/8	0.813	2.125	3.250	1.375	0.625	0.188	6.500	0.750	5.250	8.500	8.000	6.625
	3	1-3/4	0.813	2.125	3.250	1.375	0.625	0.188	6.500	0.750	5.250	8.500	8.250	6.875
8	1	1-3/8	0.813	1.813	4.250	1.813	0.688	0.250	8.500	-	7.125	8.750	8.563	9.250
	3	1-3/4	0.813	1.813	4.250	1.813	0.688	0.250	8.500	-	7.125	8.750	8.813	9.500



Side Lug
 Style C
 (NFPA MS2)

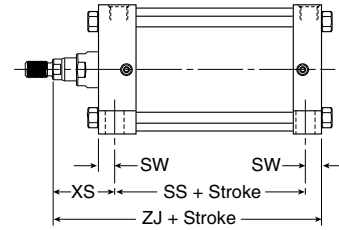
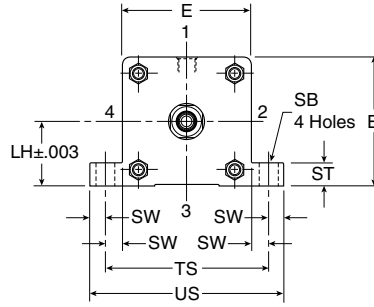
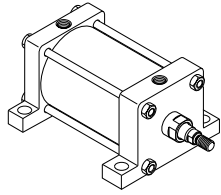

Style C

Bore size	Rod no.	Rod dia. MM	E	+/- .003 LH	SB	ST	SW	TS	US	XS	Add stroke	
											SS	ZJ
6	1	1-3/8	6.500	3.243	0.813	1.000	0.688	7.875	9.250	2.313	3.625	6.625
	3	1-3/4	6.500	3.243	0.813	1.000	0.688	7.875	9.250	2.563	3.625	6.875
8	1	1-3/8	8.500	4.243	0.813	1.000	0.688	9.875	11.250	2.313	3.750	6.750
	3	1-3/4	8.500	4.243	0.813	1.000	0.688	9.875	11.250	2.563	3.750	7.000

Side Tap
 Style F
 (NFPA MS4)

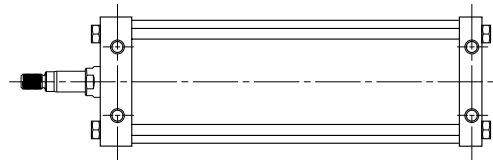
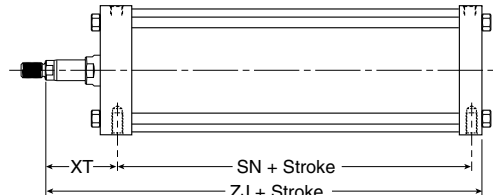
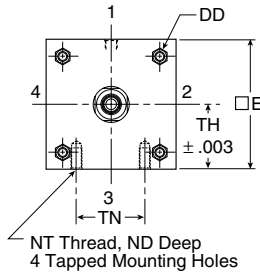
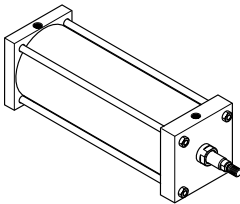

Style F

Bore size	Rod no.	Rod dia. MM	E	ND	NT	+/- .003 TH	TN	XT	Add stroke	
									SN	ZJ
6	1	1-3/8	6.500	1.125	3/4-10	3.243	3.250	2.813	3.125	6.625
	3	1-3/4	6.500	1.125	3/4-10	3.243	3.250	3.063	3.125	6.875
8	1	1-3/8	8.500	1.125	3/4-10	4.243	4.500	2.813	3.250	6.750
	3	1-3/4	8.500	1.125	3/4-10	4.243	4.500	3.063	3.250	7.000

B

Tie Rod Cylinders
 Actuator Products

3MA
 Series

4MA/4ML
 Series

3MAJ/4MAJ
 Series

4MNR
 Series

P1D
 Series



Cap Fixed Clevis

Style BB
 (NFPA MP1)

Note: For maximum swivel angle of BB mount with rear mounting plate, please reference catalog 0900P-E, cylinder accessories on page B108.

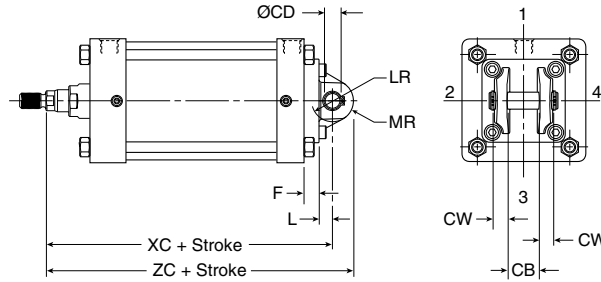
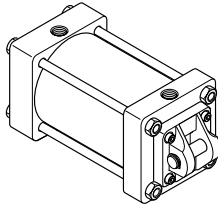

Cap Detachable Clevis

Style BC
 (NFPA MP2)

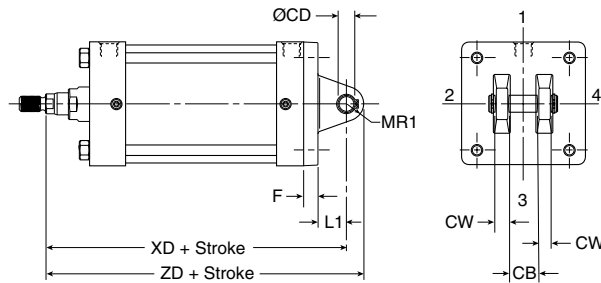
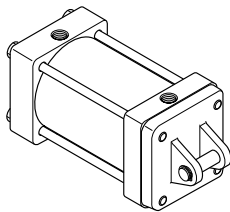

Styles BB and BC

Bore size	Rod no.	Rod dia. MM	CB	Rod dia. +.000 -0.002 CD	CW	E	F	L	LR	L1	MR	MR1	Add stroke			
													XC	XD	ZC	ZD
6	1	1-3/8	1.500	1.001	0.750	6.500	0.750	0.750	1.250	1.500	1.125	1.000	8.125	8.875	9.250	9.875
	3	1-3/4	1.500	1.001	0.750	6.500	0.750	0.750	1.250	1.500	1.125	1.000	8.375	9.125	9.500	10.125
8	1	1-3/8	1.500	1.001	0.750	8.500	0.750	0.750	1.250	1.500	1.125	1.000	8.250	9.000	9.375	10.000
	3	1-3/4	1.500	1.001	0.750	8.500	0.750	0.750	1.250	1.500	1.125	1.000	8.500	9.250	9.625	10.250

Cap Detachable Eye

Style BE
 (NFPA MP4)
 (only 6" Bore)

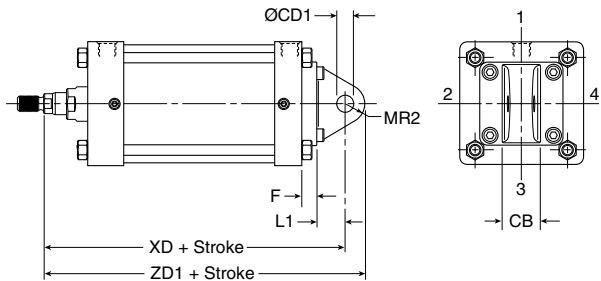
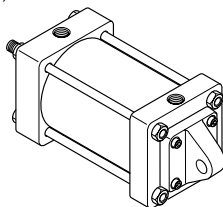

Style BE

Bore size	Rod no.	Rod dia. MM	CB	Rod dia. +.002 +.004 CD1	E	F	L1	MR2	Add stroke	
									XD	ZD1
6	1	1-3/8	1.500	1.000	6.500	0.750	1.500	1.125	8.875	10.000
	3	1-3/4	1.500	1.000	6.500	0.750	1.500	1.125	9.125	10.250

Head Trunnion

Style D
 (NFPA MT1)

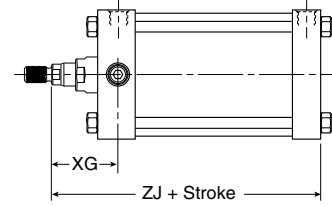
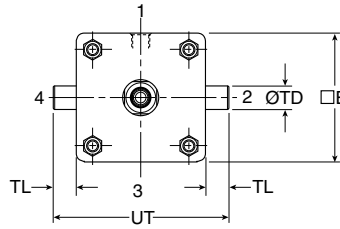
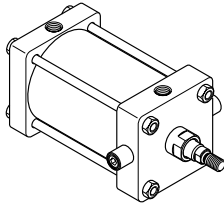

Cap Trunnion

Style DB
 (NFPA MT2)

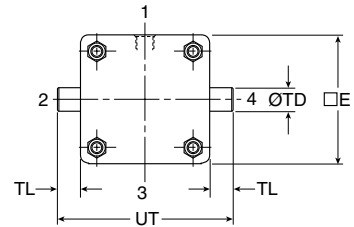
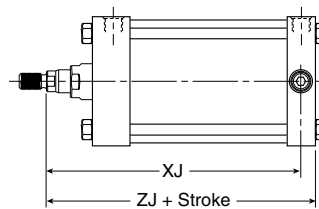
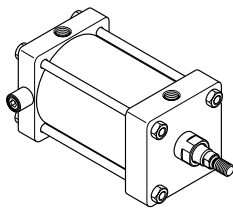

Intermediate Trunnion

Style DD
 (NFPA MT4)

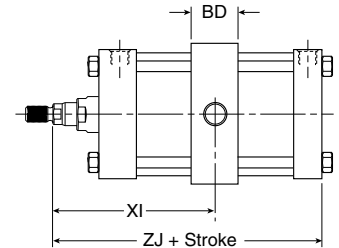
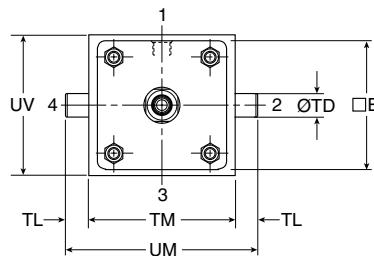
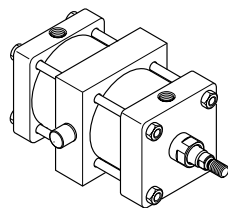

Styles D, DB and DD

Bore size	Rod no.	Rod dia. MM	E	BD	+0.000 -0.001 TD	TL	TM	UM	UT	UV	XG	Min. XI	Add stroke	
													XJ	ZJ
6	1	1-3/8	6.500	2.500	1.375	1.375	7.625	10.375	9.250	7.000	2.625	4.813	5.875	6.625
	3	1-3/4	6.500	2.500	1.375	1.375	7.625	10.375	9.250	7.000	2.875	5.063	6.125	6.875
8	1	1-3/8	8.500	2.500	1.375	1.375	9.750	12.500	11.250	9.500	2.625	4.750	6.000	6.750
	3	1-3/4	8.500	2.500	1.375	1.375	9.750	12.500	11.250	9.500	2.875	5.000	6.250	7.000

B

Tie Rod Cylinders
 Actuator Products

3MA
 Series

4MA/4ML
 Series

3MAJ/4MAJ
 Series

4MNR
 Series

P1D
 Series



Head Square

Style JB
 (NFPA ME3)

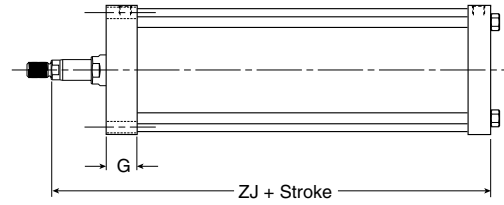
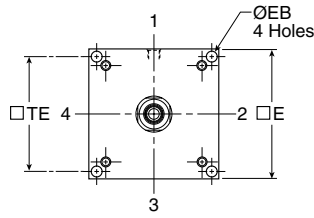
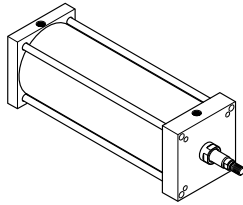

B
 Tie Rod Cylinders
 Actuator Products
 3MA Series
 4MA/4ML Series
 3MAJ/4MAJ Series
 4MNR Series
 P1D Series

Cap Square

Style HB
 (NFPA ME4)

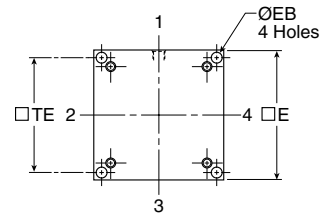
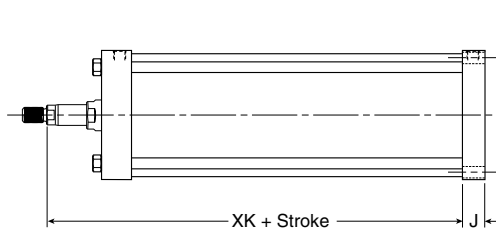
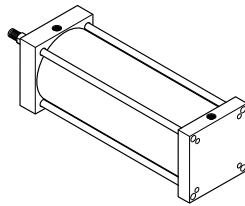

Styles JB and HB

Bore size	Rod no.	Rod dia. MM	E	EB	G	J	TE	Add stroke	
								XK	ZJ
8	1	1-3/8	8.500	0.688	1.810	1.440	7.570	5.313	6.750
	3	1-3/4	8.500	0.688	1.810	1.440	7.570	5.563	7.000

Mounting Kits and Accessories

Bore size	J (MF1)	H (MF2)	BB (MP1)	BC (MP2)	BE (MP4)	CB (MS1)	C (MS2)	G (MS7)	Kit fastener torque units	
	Head rectangular flange	Cap rectangular flange	Cap fixed clevis	Cap detachable clevis	Cap detachable eye	Side end angles	Side lug (3MA only)	Side end lug	inch-lbs	N-m
	Kit number	Kit number	Kit number	Kit number	Kit number	Kit number	Kit number	Kit number		
1-1/2	L079700150	L079700150	L079710150	L079730150	L079720150	L079740150	L079830150	L079750150	32-36	3.6-4.1
2	L079700200	L079700200	L079710200	L079730200	L079720200	L079740200	L079830200	L079750200	72-82	8-9
2-1/2	L079700250	L079700250	L079710250	L079730250	L079720250	L079740250	L079830250	L079750250	72-82	8-9
3-1/4	L079700325	L079700325	L079710325	L079730325	L079720325	L079740325	L079830325	L079750325	216-228	24-25.3
4	L079700400	L079700400	L079710400	L079730400	L079720400	L079740400	L079830400	L079750400	216-228	24-25.3
5	L079700500	L079700500	L079710500	L079730500	N/A	L079740500	L079830500	N/A	360-372	41-42

** Spacer plate not used for 4" bore or double rod cylinders

Female Rod Clevis

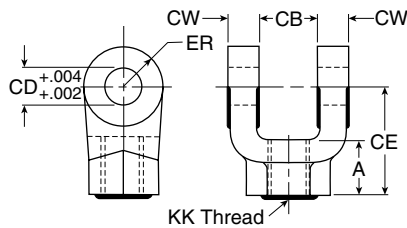

Symbol	1458030044	1458030050	1458030075	1458030088	1458030100	1458030125	1458030150
A	3/4	3/4	1-1/8	1-5/8	1-5/8	2	2-1/4
CB	3/4	3/4	1-1/4	1-1/2	1-1/2	2	2-1/2
CD	1/2	1/2	3/4	1	1	1-3/8	1-3/4
C E	1-1/2	1-1/2	2-1/8	2-15/16	2-15/16	3-3/4	4-1/2
CW	1/2	1/2	5/8	3/4	3/4	1	1-1/4
ER	1/2	1/2	3/4	1	1	1-3/8	1-3/4
KK	7/16-20	1/2-20	3/4-16	7/8-14	1-14	1-1/4-12	1-1/2-12
Load capacity (lbs)	4250	4900	11200	18800	19500	33500	45600

Rod Eye Knuckle

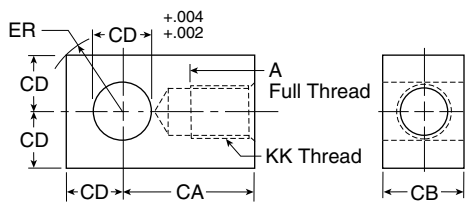

Symbol	1458040044	1458040050	1458040075	1458040088	1458040100	1458040125	1458040150
A	3/4	3/4	1-1/8	1-1/8	1-5/8	2	2-1/4
CA	1-1/2	1-1/2	2-1/16	2-3/8	2-13/16	3-7/16	4
CB	3/4	3/4	1-1/4	1-1/2	1-1/2	2	2-1/2
CD	1/2	1/2	3/4	1	1	1-3/8	1-3/4
ER	23/32	23/32	1-1/16	1-7/16	1-7/16	1-31/32	2-1/2
KK	7/16-20	1/2-20	3/4-16	7/8-14	1-14	1-1/4-12	1-1/2-12
Load capacity (lbs)	5000	5700	12100	13000	21700	33500	45000

Clevis Bracket

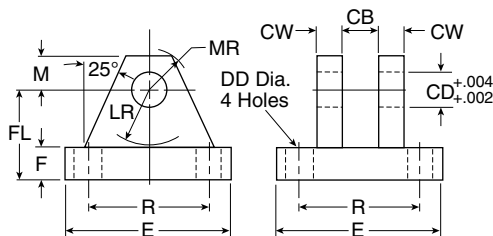

Symbol	1458050044	1458050050	1458050075	1458050100	1458050138	1458050175
CB	15/32	3/4	1-1/4	1-1/2	2	2-1/2
CD	7/16	1/2	3/4	1	1-3/8	1-3/4
CW	3/8	1/2	5/8	3/4	1	1-1/4
DD	17/64	13/32	17/32	21/32	21/32	29/32
E	2-1/4	3-1/2	5	6-1/2	7-1/2	9-1/2
F	3/8	1/2	5/8	3/4	7/8	7/8
FL	1	1-1/2	1-7/8	2-1/4	3	3-5/8
LR	5/8	3/4	1-3/16	1-1/2	2	2-3/4
M	3/8	1/2	3/4	1	1-3/8	1-3/4
MR	1/2	5/8	29/32	1-1/4	1-21/32	2-7/32
R	1.75	2.55	3.82	4.95	5.73	7.50
Load capacity (lbs)	3600	7300	14000	19200	36900	34000



Mounting Plate & Eye Bracket

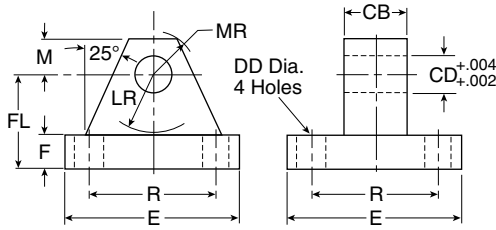

Symbol	1458060031	1458060050	1458060075	1458060100	1458060138	1458060175
CB	15/16	3/4	1-1/4	1-1/2	2	2-1/2
CD	15/16	1/2	3/4	1	1-3/8	1-3/4
DD	17/64	13/32	17/32	21/32	21/32	29/32
E	2-1/4	2-1/2	3-1/2	4-1/2	5	6-1/2
F	3/8	3/8	5/8	7/8	7/8	1-1/8
FL	1	1-1/8	17/8	2-3/8	3	3-3/8
LR	5/8	3/4	1-1/4	1-1/2	2-1/8	2-1/4
M	3/8	1/2	3/4	1	1-3/8	1-3/4
MR	1/2	9/16	7/8	1-1/4	1-5/8	2-1/8
R	1.75	1.63	2.55	3.25	3.82	4.95
Load Capacity (lbs)	1700	4100	10500	20400	21200	49480

1-1/2" to 8" Bore Cylinder Accessories

Rod end accessories can be selected by cylinder rod end thread size from Table A & B below. Mating parts for rod end accessories are listed just to the right of the knuckle or clevis selected. Mounting plates for style MP1 & MP4 cylinder mounts are selected by bore size from Table C.

Rod end thread size	Table A			Table B			Table C		
	Female rod clevis	Eye bracket	Pivot pin	Knuckle	Clevis bracket	Pivot pin	Bore size	For mtg. style MP1 cylinder	For mtg. style MP4 cylinder
7/16-20	1458030044	1458060050	0856640050	1458040044	1458050050	0856640050	1-1/2	1458060050	1458050050
1/2-20	1458030050	1458060050	0856640050	1458040050	1458050050	0856640050	2	1458060050	1458050050
3/4-16	1458030075	1458060075	0856640075	1458040075	1458050075	0856640075	2-1/2	1458060050	1458050050
7/8-14	1458030088	1458060100	0856640100	1458040088	1458050100	0856640100	3-1/4	1458060075	1458050075
1-14	1458030100	1458060100	0856640100	1458040100	1458050100	0856640100	4	1458060075	1458050075
1-1/4-12	1458030125	1458060138	0856640138	1458040125	1458050138	0856640138	5	1458060075	—
1-1/2-12	1458030150	1458060175	0856640175	1458040150	1458050175	0856640175	6	1458060100	—
							8	1458060100	—

Pivot Pin

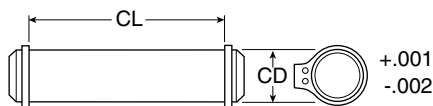

Symbol	0856640044	0856640050	0856640075	0856640100	0856640138	0856640175
CD	7/16	1/2	3/4	1	1-3/8	1-3/4
CL	1-5/16	1-7/8	2-5/8	3-1/8	4-1/8	5-3/16
Shear cap. (lbs)	6600	8600	19300	34300	65000	105200

Note: Pivot Pin must be ordered separately for single lug pivot mounting.

Maximum pivot angle for rear clevis mounts (BB mounts) and accessories

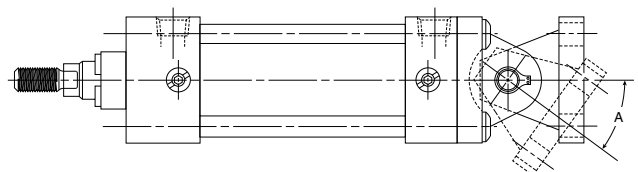

Bore	1-1/2	2	2-1/2	3-1/4	4	5	6	8
Angle A	52	43	29	50	49	45	42	42

Service Kits

Bore size	Rod dia.	Rod no.	RG - Rod gland cartridge kit. Includes gland and wiper, rod, and o-ring seals		Gland to head torque units		PK - Piston seal kit, standard lipseals. Includes piston and o-ring seals		SK - complete cylinder kit. Includes rod gland kit, piston seal kit, and cushion kits		Torque units endcap fastener or tie rod	
			Nitrile seal kit number	Fluorocarbon seals kit number	Ft-lbs	Nm	Nitrile seal kit number	Fluorocarbon seal kit number	Nitrile seal kit number	Fluorocarbon seal kit number	inch-lbs	Nm
1-1/2	5/8	1	RG04MA0061	RG04MA0065	40-45	54-61	PK1504MA01	PK1504MA05	SK15104MA1	SK15104MA5	32-36	3.6-4.1
	1	2	RG04MA0101	RG04MA0105	45-50	61-68			SK15304MA1	SK15304MA5		
2	5/8	1	RG04MA0061	RG04MA0065	40-45	54-61	PK2004MA01	PK2004MA05	SK20104MA1	SK20104MA5	72-82	8-9
	1	3	RG04MA0101	RG04MA0105	45-50	61-68			SK20304MA1	SK20304MA5		
2-1/2	5/8	1	RG04MA0061	RG04MA0065	40-45	54-61	PK2504MA01	PK2504MA05	SK25104MA1	SK25104MA5	72-82	8-9
	1	3	RG04MA0101	RG04MA0105	45-50	61-68			SK25304MA1	SK25304MA5		
3-1/4	1	1	RG04MA0101	RG04MA0105	45-50	61-68	PK3254MA01	PK3254MA05	SK32104MA1	SK32104MA5	216-228	24-25.3
	1-3/8	3	RG04MA0131	RG04MA0135	75-80	102-108			SK32304MA1	SK32304MA5		
4	1	1	RG04MA0101	RG04MA0105	45-50	61-68	PK4004MA01	PK4004MA05	SK40104MA1	SK40104MA5	216-228	24-25.3
	1-3/8	3	RG04MA0131	RG04MA0135	75-80	102-108			SK40304MA1	SK40304MA5		
5	1	1	RG04MA0101	RG04MA0105	45-50	61-68	PK5004MA01	PK5004MA05	SK50104MA1	SK50104MA5	360-372	41-42
	1-3/8	3	RG04MA0131	RG04MA0135	75-80	102-108			SK50304MA1	SK50304MA5		
6	1-3/8	1	RG04MA0131	RG04MA0135	75-80	102-108	PK6004MA01	PK6004MA05	SK60104MA1	SK60104MA5	420-432	48-49
	1-3/4	3	RG04MA0171	RG04MA0175	90-95	122-129			SK60304MA1	SK60304MA5		
8	1-3/8	1	RG04MA0131	RG04MA0135	75-80	102-108	PK8004MA01	PK8004MA05	SK80104MA1	SK80104MA5	960-972	109-115
	1-3/4	3	RG04MA0171	RG04MA0175	90-95	122-129			SK80304MA1	SK80304MA5		

B

**Tie Rod Cylinders
Actuator Products**

**3MA
Series**

**4MA/4ML
Series**

**3MAJ/4MAJ
Series**

**4MNR
Series**

**P1D
Series**



3MAJ/4MAJ Series

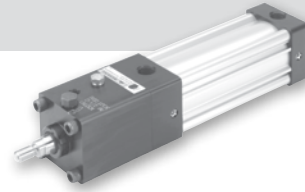

- Industry leading NFPA interchangeable rod lock cylinder with flexible construction
- Rod lock holding force equivalent to cylinder output force at 100 PSIG
- Bore sizes – 1-1/2", 2", 2-1/2", 3-1/4", 4", 5", 6" and 8"
- 17 standard styles mounting styles available
- Available in any practical stroke length
- Rod diameters – 5/8", 1", 1-3/8" and 1-3/4"
- Single rod end or double rod ends
- Adjustable cushions are standard at both ends
- Manual override feature standard on all configurations

Operating information

Operating pressure: 100 PSIG (7 bar) maximum air pressure, except 2" bore with 1" rod rated at 80 PSIG)
 60 PSIG (4.1 bar) minimum air pressure to release rod lock

Temperature range –
 Standard seals -10°F to 165°F (-23°C to 74°C)
 Fluorocarbon seals -10°F to 250°F (-23°C to 121°C)

Filtration requirements: 40 micron, dry filtered air

Ordering information

2.00	C	J	4MAJ	U	1	4	A	C	6.000
Bore size	Double Rod Cylinder ¹²	Series	Ports ⁴	Piston rod number	Special modification	Cushion head end	Piston rod thread type	Cushion cap end	Stroke length
1.50 ¹	Specify "K" only if double rod cylinder is required.	4MAJ 4MA rod lock cylinder	U NPTF	Specify rod code number for required diameter. ⁸	Specify "S" only for special modification other than rod end, and then describe modification in item notes. (Includes 4MAJ with Linear Position Sensor Option) ⁷	C Cushioned head end "C" is required	A Standard (UNF unified thread)	C Cushioned cap end "C" is required	Specify stroke length required in inches. ⁸
2.00	Mounting style	3MAJ 3MA rod lock cylinder	R BSPP				W BSF British fine		
2.50	Specify mounting style code (see table on following page).		B BSPT				M* Metric		
3.25			T SAE						
4.00									
5.00									
6.00 ^{2, 11}									
8.00 ^{2, 11}									
Cylinder construction			Seals				Rod material and gland code		
Blank* Standard (extruded body, standard round lobe orientation)			Blank Standard (nitrile seals)				Blank Standard rod and gland		
A* Extruded body, round lobe orientation rotated 90 degrees from standard			V Fluorocarbon seals ^{2, 5}				H Standard rod and HI LOAD gland		
N* Extruded body, round lobe orientation rotated 180 degrees from standard			E Fluorocarbon rod wiper and rod seal only ⁶				Y 17-4 PH stainless steel rod and standard gland		
Z* Extruded body, round lobe orientation rotated 270 degrees from standard							Z 17-4 PH stainless steel rod and HI LOAD gland		
T Aluminum round tube and carbon steel tie rods & nuts			Piston rod thread style						
			4 Small male						
			8 Intermediate male						
			9 Short female						
			55 For use with split coupler ⁹						
			3 Special (and specify all dimensions required)						
Piston type ¹¹									
Blank Standard (lipseals and magnetic ring) ¹²									
1 Lipseals, no magnetic ring ¹²									
2 Lipseals, no magnetic ring (aluminum piston)									
3 Lipseals and magnetic ring (aluminum piston)									
4 Bumper seals, no magnetic ring									
6 Bumper seals and magnetic ring									
B Lipseals, 1/4" thick bumpers both ends ³									
H Lipseals, 1/4" thick bumper head end ³									
C Lipseals, 1/4" thick bumper cap end ³									
D Lipseals and magnetic ring, 1/4" thick bumpers both ends ³									
F Lipseals and magnetic ring, 1/4" thick bumper head end ³									
R Lipseals and magnetic ring, 1/4" thick bumper cap end ³									

* Please reference catalog 0900P-E, table on page B10. Only applies to 1-1/2" to 4" bore.

¹ Not available with 1" rod diameter (rod number 2) for 1-1/2" bore. Not available with Linear Position Sensor Option (LPSO).

² Not available for 3MAJ, please specify 4MAJ.

³ Addition of 1/4" bumper results in a 1/4" stroke loss per bumper, per end. For example, a 6" stroke cylinder with 1/4" bumpers at both ends (option B) has an effective stroke of 5-1/2".

⁴ Port thread styles only for base cylinder. Rod lock port is always NPTF. If a different rod lock port thread style is required, place an "S" for special in the Special Modification field and indicate the desired rod lock port thread style in the item notes. NPTF cylinder ports are must be ordered for 3MAJ.

⁵ Fluorocarbon seals for 4MAJ are only for external chemical compatibility applications, not high temperature.

⁶ Used for external chemical compatibility applications, not high temperature.

⁷ For Linear Position Sensor Option (LPSO), please include the following information for the Special Modification item notes:
 a. Sensor part number (please reference catalog 0900P-E, pages B100-B104)
 b. Sensor position
 c. Port position (if other than position 1)
 d. Length of stop tubing, gross stroke and net stroke (if required)
 LPSO not available for 3MAJ, please specify 4MAJ. Cylinder dimensions will approximate dimensions for 4MAJ. Piston Type option (blank), 3, 6, D, F or R is required. Please consult the Actuator Division for additional information.

⁸ Review Piston Rod Selection Chart, please reference catalog 0900P-E, on page A14 to determine proper piston rod diameter.

⁹ For additional information regarding this style, please reference catalog 0900P-E, page B105. If non-standard Rod Material and Gland Code is required with this option, please place an "S" for special in Special Modification field and specify Rod Material and Gland Code in the item notes.

¹⁰ If a stop tube is required, specify gross stroke (net stroke + stop tube) in the model number, then place an "S" for special in the Special Modification field and specify the stop tube length in the item notes. Not available with Piston Types (blank) and 1 for 1-1/2" - 5" bore cylinders. Stop tube not available for 3MAJ, please specify 4MAJ.

¹¹ 6"-8" bore 4MAJ can accept only Piston Types (blank) and 3. The (blank) piston for 6"-8" bores is aluminum, lipseals, no magnetic ring. Composite pistons not available with oversize rod number 3.

¹² Double rod cylinders not available with composite piston type.

For ordering purposes, when special options or common modifications are requested, the factory will assign a sequential part number in place of the model number.

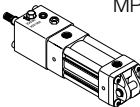
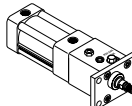
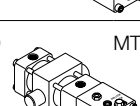
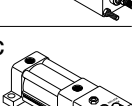
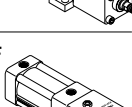
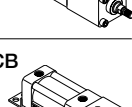
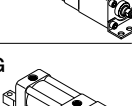

3MAJ*/4MAJ Mounting Styles for 6" to 8" Bore

Mounting style	NFPA mounting	Description	Bore size	Mounting style	NFPA mounting	Description	Bore size
T 	MX0	No Mount	1-1/2 - 8	BB 	MP1	Cap Fixed Clevis	1-1/2 - 8
J 	MF1	Head Rectangular Flange	1-1/2 - 6	BC 	MP2	Cap Detachable Clevis	1-1/2 - 8
H 	MF2	Cap Rectangular Flange	1-1/2 - 6	BE 	MP4	Cap Detachable Eye	1-1/2 - 6
TB 	MX3	Tie Rods Extended Head End	1-1/2 - 8	D 	MT1	Head Trunnion	1-1/2 - 8
TC 	MX2	Tie Rods Extended Cap End	1-1/2 - 8	DB 	MT2	Cap Trunnion	1-1/2 - 8
TD 	MX1	Tie Rods Extended Both Ends	1-1/2 - 8	DD 	MT4	Intermediate Trunnion	1-1/2 - 8
C 	MS2	Side Lug	1-1/2 - 8	KT 	MDX0	Double Rod End, No Mount	1-1/2 - 8
F 	MS4	Side Tap	1-1/2 - 8	* 3MAJ utilizes base 3MA cylinder and is available in 1-1/2" to 5" bore sizes. Mounting style codes C, D and DB not available for 3MAJ			
CB 	MS1	Side End Angle	1-1/2 - 8				
G 	MS7	Side End Lug	1-1/2 - 4				

B	Tie Rod Cylinders Actuator Products
	3MA Series
4MA/4ML Series	
3MAJ/4MAJ Series	
4MNR Series	
P1D Series	

Sensors

For sensors see page B339.



3MAJ/4MAJ Series Single Rod Dimensions

No Mount Basic
 Style T
 (NFPA MX0)

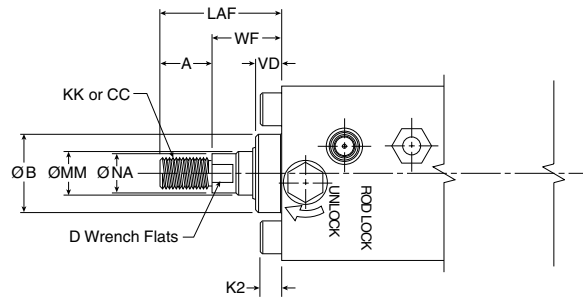
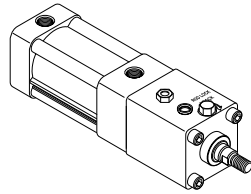

For dimensions of all standard rod end styles, see next page.

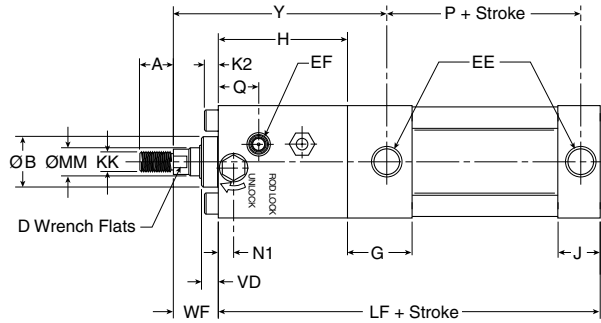
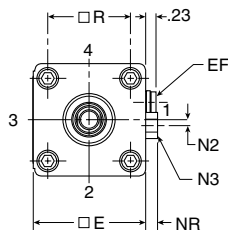

Style T

Bore size	Rod no.	Rod dia. MM	Thread		A	AA	+0.000 -0.002 B	D	E	EE (NPTF)	EF (NPTF)	G	H	J
			Style 8 CC	Style 4 & 9 KK										
1-1/2	1	5/8	1/2-20	7/16-20	0.750	2.020	1.124	1/2	2.000	3/8	1/8	1.438	2.625	0.938
	2	5/8	1/2-20	7/16-20	0.750	2.600	1.124	1/2	2.500	3/8	1/8	1.375	2.875	0.937
	3	1	7/8-14	3/4-16	1.125	2.600	1.499	7/8	2.500	3/8	1/8	1.375	3.875	0.937
2-1/2	1	5/8	1/2-20	7/16-20	0.750	3.100	1.124	1/2	3.000	3/8	1/8	1.344	2.875	0.938
	3	1	7/8-14	3/4-16	1.125	3.100	1.499	7/8	3.000	3/8	1/8	1.344	4.000	0.938
3-1/4	1	1	7/8-14	3/4-16	1.125	3.900	1.499	7/8	3.750	1/2	1/4	1.594	4.500	1.125
	3	1-3/8	1-1/4-12	1-14	1.625	3.900	1.999	1-1/8	3.750	1/2	1/4	1.594	4.875	1.125
4	1	1	7/8-14	3/4-16	1.125	4.700	1.499	7/8	4.500	1/2	1/4	1.594	4.875	1.125
	3	1-3/8	1-1/4-12	1-14	1.625	4.700	1.999	1-1/8	4.500	1/2	1/4	1.594	5.125	1.125
5	1	1	7/8-14	3/4-16	1.125	5.800	1.499	7/8	5.500	1/2	1/4	1.594	5.375	1.219
	3	1-3/8	1-1/4-12	1-14	1.625	5.800	1.999	1-1/8	5.500	1/2	1/4	1.594	5.750	1.219

Bore size	Rod no.	Rod dia. MM	K2	LAF	N1	N2	Hex N3	NA	NR	Q	R	VD	WF	Y	Add stroke	
															LF	P
1-1/2	1	5/8	0.250	1.750	0.220	0.140	5/16	0.563	0.190	0.715	1.430	0.375	1.000	4.500	6.250	2.313
	2	5/8	0.313	1.750	0.340	0.130	1/2	0.563	0.265	0.895	1.840	0.375	1.000	4.750	6.500	2.313
	3	1	0.313	2.500	0.338	0.146	1/2	0.938	0.275	1.065	1.840	0.500	1.375	6.125	7.500	2.313
2-1/2	1	5/8	0.313	1.750	0.346	0.150	1/2	0.563	0.265	0.755	2.190	0.500	1.000	4.813	6.625	2.375
	3	1	0.313	2.500	0.346	0.148	1/2	0.938	0.265	1.120	2.190	0.500	1.375	6.313	7.750	2.375
3-1/4	1	1	0.375	2.500	0.631	0.180	5/8	0.938	0.340	1.510	2.760	0.500	1.375	6.938	8.750	2.625
	3	1-3/8	0.375	3.250	0.813	0.247	5/8	1.313	0.350	1.645	2.760	0.625	1.625	7.563	9.125	2.625
4	1	1	0.375	2.500	0.625	0.240	7/8	0.938	0.500	1.725	3.320	0.500	1.375	7.313	9.125	2.625
	3	1-3/8	0.375	3.250	0.771	0.276	7/8	1.313	0.490	1.679	3.320	0.750	1.625	7.813	9.375	2.625
5	1	1	0.500	2.500	0.720	0.220	7/8	0.938	0.500	1.995	4.100	0.500	1.375	7.813	9.875	2.875
	3	1-3/8	0.500	3.250	0.720	0.220	7/8	1.313	0.490	2.330	4.100	0.750	1.625	8.438	10.250	2.875



B
 Tie Rod Cylinders
 Actuator Products
 3MA Series
 4MA/4ML Series
 3MAJ/4MAJ Series
 4MNR Series
 P1D Series

Rod End Dimensions

Thread Style 4
 (NFPA Style SM)
 Small Male

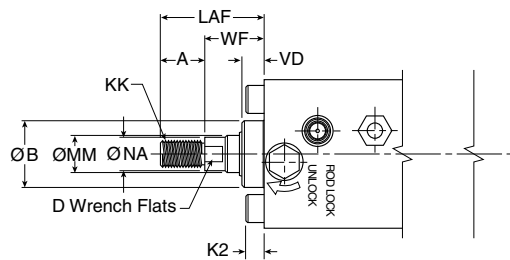

Thread Style 8
 (NFPA Style IM)
 Intermediate Male

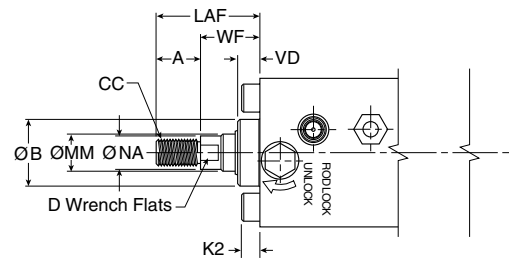

Thread Style 9
 (NFPA Style SF)
 Short Female

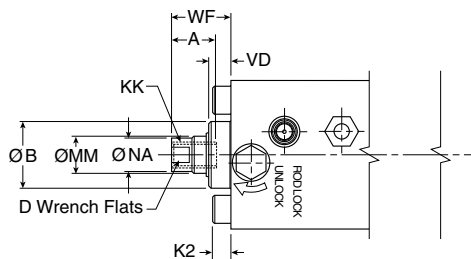

Thread Style 55
 For use with Split Coupler
 (please reference catalog 0900P-E, page B105 for more information)

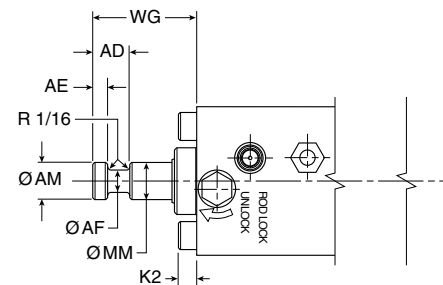

Thread Style 3 - "Special Thread"

Special threads, rod extensions, rod eyes, blanks, etc. are also available. To order, specify "Style 3" and give desired dimensions for KK or CC, A and W or WF. If otherwise special, please supply dimensioned sketch.

Rod End Dimensions

Bore size	Rod no.	Rod dia. MM	Thread		A	AD	AE	AF	AM	+0.000 -0.002		K2	LAF	NA	VD	WF	WG
			Style 8 CC	Style 4 & 9 KK						B	D						
1-1/2	1	5/8	1/2-20	7/16-20	0.750	0.625	0.250	0.375	0.570	1.124	1/2	0.250	1.750	0.563	0.375	1.000	1.750
	3	1	7/8-14	3/4-16	1.125	0.938	0.375	0.688	0.950	1.499	7/8	0.313	2.500	0.938	0.500	1.375	2.375
2	1	5/8	1/2-20	7/16-20	0.750	0.625	0.250	0.375	0.570	1.124	1/2	0.313	1.750	0.563	0.375	1.000	1.750
	3	1	7/8-14	3/4-16	1.125	0.938	0.375	0.688	0.950	1.499	7/8	0.313	2.500	0.938	0.500	1.375	2.375
2-1/2	1	5/8	1/2-20	7/16-20	0.750	0.625	0.250	0.375	0.570	1.124	1/2	0.313	1.750	0.563	0.500	1.000	1.750
	3	1	7/8-14	3/4-16	1.125	0.938	0.375	0.688	0.950	1.499	7/8	0.313	2.500	0.938	0.500	1.375	2.375
3-1/4	1	1	7/8-14	3/4-16	1.125	0.938	0.375	0.688	0.950	1.499	7/8	0.375	2.500	0.938	0.500	1.375	2.375
	3	1-3/8	1-1/4-12	1-14	1.625	1.063	0.375	0.875	1.320	1.999	1-1/8	0.375	3.250	1.313	0.625	1.625	2.750
4	1	1	7/8-14	3/4-16	1.125	0.938	0.375	0.688	0.950	1.499	7/8	0.375	2.500	0.938	0.500	1.375	2.375
	3	1-3/8	1-1/4-12	1-14	1.625	1.063	0.375	0.875	1.320	1.999	1-1/8	0.375	3.250	1.313	0.750	1.625	2.750
5	1	1	7/8-14	3/4-16	1.125	0.938	0.375	0.688	0.950	1.499	7/8	0.500	2.500	0.938	0.500	1.375	2.375
	3	1-3/8	1-1/4-12	1-14	1.625	1.063	0.375	0.875	1.320	1.999	1-1/8	0.500	3.250	1.313	0.750	1.625	2.750

B

Tie Rod Cylinders
 Actuator Products

3MA Series

4MA/4ML Series

3MAJ/4MAJ Series

4MNR Series

P1D Series



Head Rectangular Flange

Style J
 (NFPA MF1)

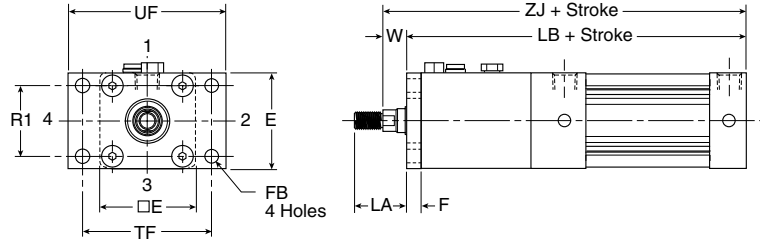
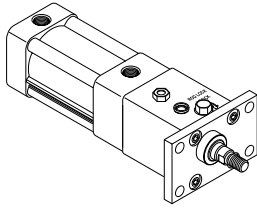

Note: Style J has a W dimension instead of WF and a LA dimension instead of LAF because of the flange installation. Please use dimensions W and LA regarding rod ends only for Style J. For reference, $WF = W + F$ and $LA = W + A$.

Cap Rectangular Flange

Style H
 (NFPA MF2)

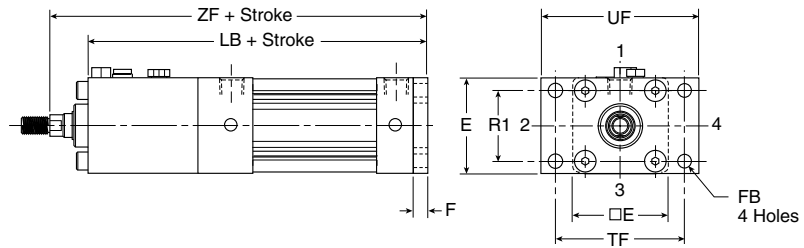
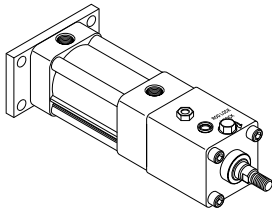

Styles J and H

Bore size	Rod no.	Rod dia. MM	A	E	F	FB	LA	R1	TF	UF	W	Add stroke		
												LB	ZF	ZJ
1-1/2	1	5/8	0.750	2.000	0.375	0.313	1.375	1.430	2.750	3.375	0.625	6.625	7.625	7.250
	1	5/8	0.750	2.500	0.375	0.375	1.375	1.840	3.375	4.125	0.625	6.875	7.875	7.500
	3	1	1.125	2.500	0.375	0.375	2.125	1.840	3.375	4.125	1.000	7.875	9.250	8.875
2-1/2	1	5/8	0.750	3.000	0.375	0.375	1.375	2.190	3.875	4.625	0.625	7.000	8.000	7.625
	3	1	1.125	3.000	0.375	0.375	2.125	2.190	3.875	4.625	1.000	8.125	9.500	9.125
3-1/4	1	1	1.125	3.750	0.625	0.438	1.875	2.760	4.688	5.500	0.750	9.375	10.750	10.125
	3	1-3/8	1.625	3.750	0.625	0.438	2.625	2.760	4.688	5.500	1.000	9.750	11.375	10.750
4	1	1	1.125	4.500	0.625	0.438	1.875	3.320	5.438	6.250	0.750	9.750	11.125	10.500
	3	1-3/8	1.625	4.500	0.625	0.438	2.625	3.320	5.438	6.250	1.000	10.000	11.625	11.000
5	1	1	1.125	5.500	0.625	0.563	1.875	4.100	6.625	7.625	0.750	10.500	11.875	11.250
	3	1-3/8	1.625	5.500	0.625	0.563	2.625	4.100	6.625	7.625	1.000	10.875	12.500	11.875

B
 Tie Rod Cylinders
 Actuator Products
 Series
 3MA
 Series
 4MA/4ML
 Series
 3MAJ/4MAJ
 Series
 4MNR
 Series
 P1D
 Series



Tie Rods Extended Head End Mount

Style TB
(NFPA MX3)

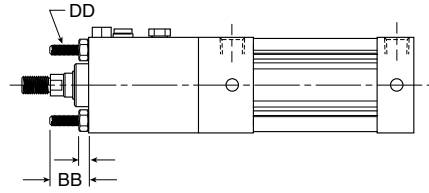
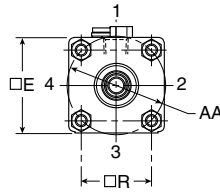
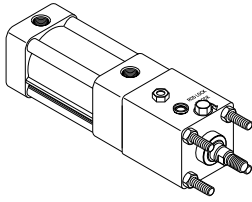

Tie Rods Extended Cap End Mount

Style TC
(NFPA MX2)

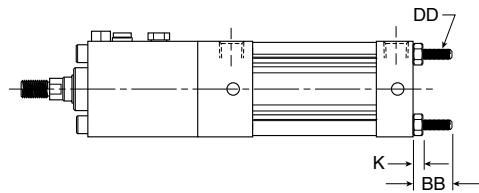
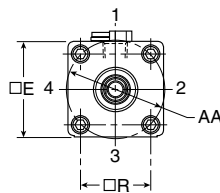
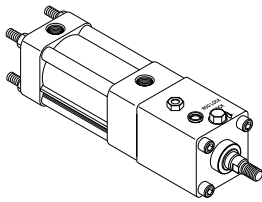

Tie Rods Extended Both Ends Mount

Style TD
(NFPA MX1)

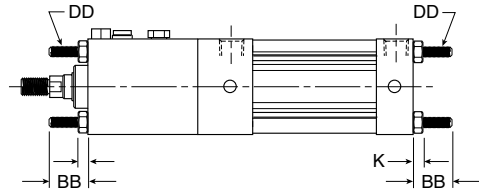
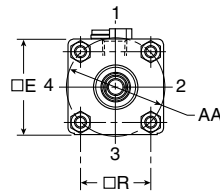
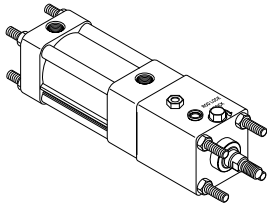

Styles TB, TC and TD

Bore size	Rod no.	Rod dia. MM	AA	BB	DD	E	K	R
1-1/2	1	5/8	2.020	1.000	1/4-28	2.000	0.250	1.430
2	1	5/8	2.600	1.125	5/16-24	2.500	0.313	1.840
	3	1	2.600	1.125	5/16-24	2.500	0.313	1.840
2-1/2	1	5/8	3.100	1.125	5/16-24	3.000	0.313	2.190
	3	1	3.100	1.125	5/16-24	3.000	0.313	2.190
3-1/4	1	1	3.900	1.375	3/8-24	3.750	0.375	2.760
	3	1-3/8	3.900	1.375	3/8-24	3.750	0.375	2.760
4	1	1	4.700	1.375	3/8-24	4.500	0.375	3.320
	3	1-3/8	4.700	1.375	3/8-24	4.500	0.375	3.320
5	1	1	5.800	1.813	1/2-20	5.500	0.438	4.100
	3	1-3/8	5.800	1.813	1/2-20	5.500	0.438	4.100

B

Tie Rod Cylinders
Actuator Products

3MA Series

4MA/4ML Series

3MAJ/4MAJ Series

4MNR Series

P1D Series

Side Lug Mount

Style C (only 4MAJ)
 (NFPA MS2)

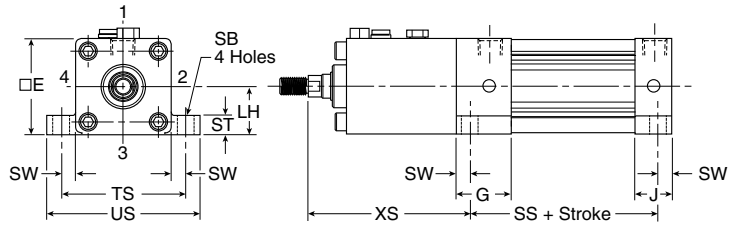
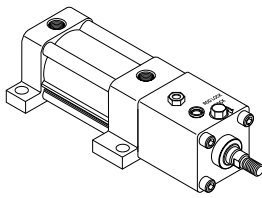

Style C

Bore size	Rod no.	Rod dia. MM	E	G	J	+/- .003 LH	SB	ST	SW	TS	US	XS	Add stroke SS
1-1/2	1	5/8	2.000	1.438	0.938	0.993	0.438	0.500	0.375	2.750	3.500	4.000	2.875
	2	5/8	2.500	1.375	0.937	1.243	0.438	0.500	0.375	3.250	4.000	4.250	2.875
2	3	1	2.500	1.375	0.937	1.243	0.438	0.500	0.375	3.250	4.000	5.625	2.875
	1	5/8	3.000	1.344	0.938	1.493	0.438	0.500	0.375	3.750	4.500	4.250	3.000
2-1/2	3	1	3.000	1.344	0.938	1.493	0.438	0.500	0.375	3.750	4.500	5.750	3.000
	1	1	3.750	1.594	1.125	1.868	0.563	0.750	0.500	4.750	5.750	6.375	3.250
3-1/4	3	1-3/8	3.750	1.594	1.125	1.868	0.563	0.750	0.500	4.750	5.750	7.000	3.250
	1	1	4.500	1.594	1.125	2.243	0.563	0.750	0.500	5.500	6.500	6.750	3.250
4	3	1-3/8	4.500	1.594	1.125	2.243	0.563	0.750	0.500	5.500	6.500	7.250	3.250
	1	1	5.500	1.594	1.219	2.743	0.813	1.000	0.688	6.875	8.250	7.438	3.125
5	3	1-3/8	5.500	1.594	1.219	2.743	0.813	1.000	0.688	6.875	8.250	8.063	3.125

Side Tap Mount

Style F
 (NFPA MS4)

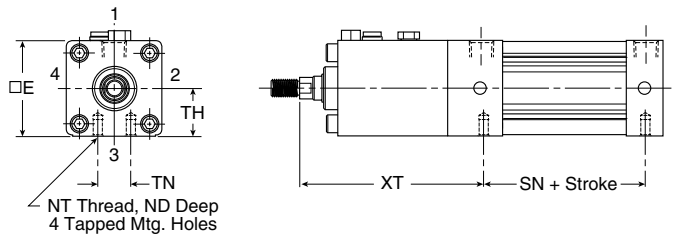
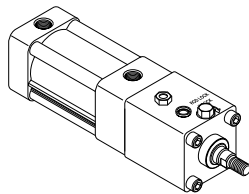

Style F

Bore size	Rod no.	Rod dia. MM	E	ND	NT	+/- .003 TH	TN	XT	Add stroke SN
1-1/2	1	5/8	2.000	0.375	1/4-20	0.993	0.625	4.563	2.250
	2	5/8	2.500	0.438	5/16-18	1.243	0.875	4.813	2.250
2	3	1	2.500	0.375	5/16-18	1.243	0.875	6.188	2.250
	1	5/8	3.000	0.625	3/8-16	1.493	1.250	4.813	2.375
2-1/2	3	1	3.000	0.625	3/8-16	1.493	1.250	6.313	2.375
	1	1	3.750	0.750	1/2-13	1.868	1.500	6.938	2.625
3-1/4	3	1-3/8	3.750	0.750	1/2-13	1.868	1.500	7.563	2.625
	1	1	4.500	0.750	1/2-13	2.243	2.063	7.313	2.625
4	3	1-3/8	4.500	0.750	1/2-13	2.243	2.063	7.813	2.625
	1	1	5.500	0.938	5/8-11	2.743	2.688	7.813	2.875
5	3	1-3/8	5.500	0.938	5/8-11	2.743	2.688	8.438	2.875



Side End Angle Mount

Style CB
 (NFPA MS1)

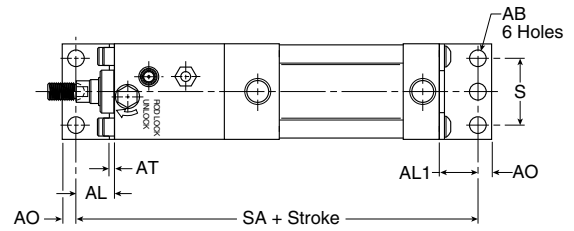
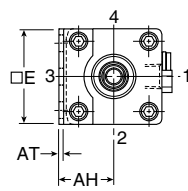
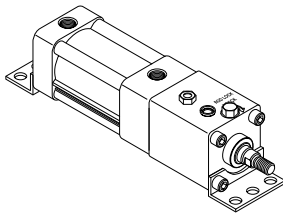

Style CB

Bore size	Rod no.	Rod dia. MM	AB	AH	AL	AL1	AO	AT	E	S	Add stroke
											SA
1-1/2	1	5/8	0.438	1.188	1.000	1.000	0.375	0.125	2.000	1.250	8.250
	3	1	0.438	1.438	1.000	1.000	0.375	0.125	2.500	1.750	8.500
2	1	5/8	0.438	1.438	1.000	1.000	0.375	0.125	2.500	1.750	9.500
	3	1	0.438	1.438	1.000	1.000	0.375	0.125	2.500	1.750	9.500
2-1/2	1	5/8	0.438	1.625	1.000	1.000	0.375	0.125	3.000	2.250	8.625
	3	1	0.438	1.625	1.000	1.000	0.375	0.125	3.000	2.250	9.750
3-1/4	1	1	0.563	1.938	1.250	1.250	0.500	0.125	3.750	2.750	11.250
	3	1-3/8	0.563	1.938	1.250	1.250	0.500	0.125	3.750	2.750	11.625
4	1	1	0.563	2.250	1.875	1.250	0.500	0.125	4.500	3.500	12.250
	3	1-3/8	0.563	2.250	1.875	1.250	0.500	0.125	4.500	3.500	12.500
5	1	1	0.688	2.750	1.375	1.375	0.625	0.188	5.500	4.250	12.625
	3	1-3/8	0.688	2.750	1.375	1.375	0.625	0.188	5.500	4.250	13.000

Side End Lug Mount

Style G
 (NFPA MS7)

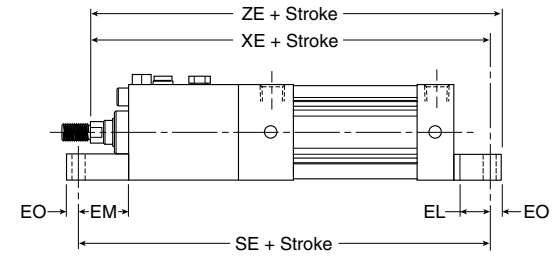
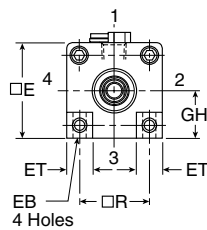
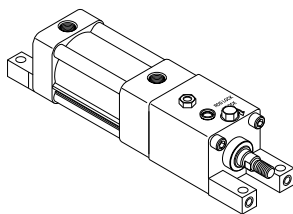

Style G

Bore size	Rod no.	Rod dia. MM	E	EB	EL	EM	EO	ET	+/- .003 GH	R	Add stroke		
											SE	XE	ZE
1-1/2	1	5/8	2.000	0.281	0.750	1.125	0.250	0.563	0.993	1.430	8.125	8.000	8.250
	3	1	2.500	0.344	0.938	1.313	0.313	0.688	1.243	1.840	8.750	8.438	8.750
2	1	5/8	2.500	0.344	0.938	1.313	0.313	0.688	1.243	1.840	9.750	9.813	10.125
	3	1	2.500	0.344	0.938	1.313	0.313	0.688	1.243	1.840	9.750	9.813	10.125
2-1/2	1	5/8	3.000	0.344	1.063	1.438	0.313	0.813	1.493	2.190	9.125	8.688	9.000
	3	1	3.000	0.344	1.063	1.438	0.313	0.813	1.493	2.190	10.250	10.188	10.500
3-1/4	1	1	3.750	0.406	0.875	1.500	0.375	1.000	1.868	2.760	11.125	11.000	11.375
	3	1-3/8	3.750	0.406	0.875	1.500	0.375	1.000	1.868	2.760	11.500	11.625	12.000
4	1	1	4.500	0.406	1.000	1.625	0.375	1.188	2.243	3.320	11.750	11.500	11.875
	3	1-3/8	4.500	0.406	1.000	1.625	0.375	1.188	2.243	3.320	12.000	12.000	12.375

B
 Tie Rod Cylinders
 Actuator Products

3MA Series

4MA/4ML Series

3MAJ/4MAJ Series

4MNR Series

P1D Series



Parker Pneumatic

3MAJ/4MAJ Series

Cap Fixed Clevis Mount

Style BB
(NFPA MP1)

NOTE: For maximum swivel angle of BB mount with rear mounting plate, please reference catalog 0900P-E, cylinder accessories on page B108.

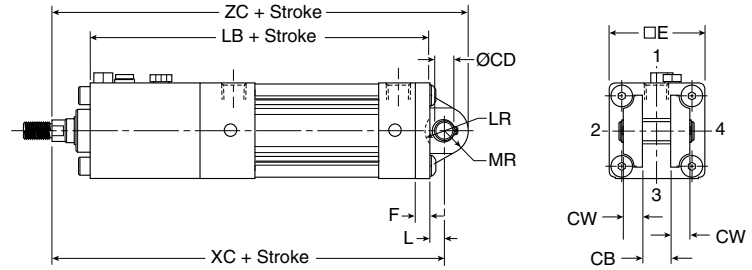
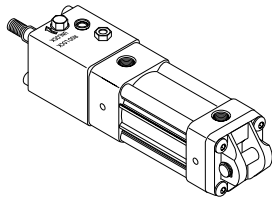

Cap Detachable Clevis Mount

Style BC
(NFPA MP2)

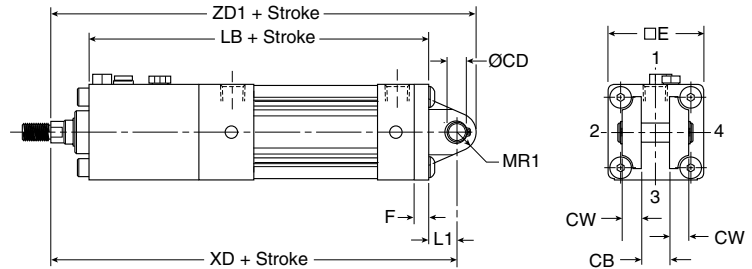
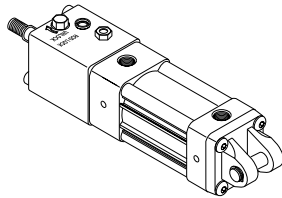

Styles BB and BC

Bore size	Rod no.	Rod dia. MM	CB	+0.002 -0.002 CD	CW	E	F	L	L1	LR	MR	MR1	Add stroke				
													LB	XC	XD	ZC	ZD1
1-1/2	1	5/8	0.750	0.501	0.500	2.000	0.375	0.375	0.750	0.750	0.625	0.500	6.625	8.000	8.375	8.625	8.875
	2	1	0.750	0.501	0.500	2.500	0.375	0.375	0.750	0.750	0.625	0.500	6.875	8.250	8.625	8.875	9.125
2	3	1	0.750	0.501	0.500	2.500	0.375	0.375	0.750	0.750	0.625	0.500	7.875	9.625	10.000	10.250	10.500
	1	5/8	0.750	0.501	0.500	3.000	0.375	0.375	0.750	0.750	0.625	0.500	7.000	8.375	8.750	9.000	9.250
2-1/2	3	1	0.750	0.501	0.500	3.000	0.375	0.375	0.750	0.750	0.625	0.500	8.125	9.875	10.250	10.500	10.750
	1	1	1.250	0.751	0.625	3.750	0.625	0.625	1.250	1.000	0.938	0.750	9.375	11.375	12.000	12.313	12.750
3-1/4	3	1-3/8	1.250	0.751	0.625	3.750	0.625	0.625	1.250	1.000	0.938	0.750	9.750	12.000	12.625	12.938	13.375
	1	1	1.250	0.751	0.625	4.500	0.625	0.625	1.250	1.000	0.938	0.750	9.750	11.750	12.375	12.688	13.125
4	3	1-3/8	1.250	0.751	0.625	4.500	0.625	0.625	1.250	1.000	0.938	0.750	10.000	12.250	12.875	13.188	13.625
	1	1	1.250	0.751	0.625	5.500	0.625	0.625	1.250	1.000	0.938	0.750	10.500	12.500	13.125	13.438	13.875
5	3	1-3/8	1.250	0.751	0.625	5.500	0.625	0.625	1.250	1.000	0.938	0.750	10.875	13.125	13.750	14.063	14.500

B
 Tie Rod Cylinders
 Actuator Products
 Series
 3MA
 Series
 4MA/4ML
 Series
 3MAJ/4MAJ
 Series
 4MNR
 Series
 P1D
 Series



Cap Detachable Eye Mount*

Style BE
 (NFPA MP4)

* Not available for
 5" bore 3MAJ,
 please specify 4MAJ.

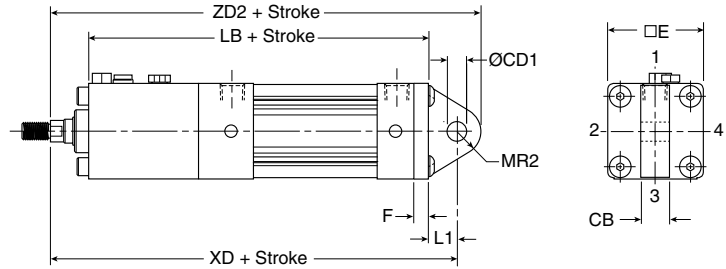
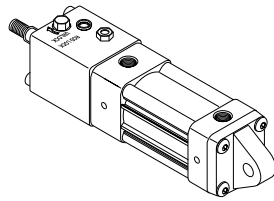

Style BE

Bore size	Rod no.	Rod dia. MM	CB	+0.002 +0.004 CD1	E	F	L1	MR2	Add Stroke		
									LB	XD	ZD2
1-1/2	1	5/8	0.750	0.500	2.000	0.375	0.750	0.625	6.625	8.375	9.000
	3	1	0.750	0.500	2.500	0.375	0.750	0.625	7.875	10.000	10.625
2	1	5/8	0.750	0.500	2.500	0.375	0.750	0.625	6.875	8.625	9.250
	3	1	0.750	0.500	2.500	0.375	0.750	0.688	7.000	8.750	9.438
2-1/2	1	5/8	0.750	0.500	3.000	0.375	0.750	0.688	8.125	10.250	10.938
	3	1	0.750	0.500	3.000	0.375	0.750	0.688	8.125	10.250	10.938
3-1/4	1	1	1.250	0.750	3.750	0.625	1.250	0.875	9.375	12.000	12.875
	3	1-3/8	1.250	0.750	3.750	0.625	1.250	0.875	9.750	12.625	13.500
4	1	1	1.250	0.750	4.500	0.625	1.250	0.875	9.750	12.375	13.250
	3	1-3/8	1.250	0.750	4.500	0.625	1.250	0.875	10.000	12.875	13.750
5*	1	1	1.250	0.750	5.500	0.625	1.250	0.875	10.500	13.125	14.000
	3	1-3/8	1.250	0.750	5.500	0.625	1.250	0.875	10.875	13.750	14.625

Intermediate Trunnion Mount

Style DD
 (NFPA MT4)

Note: Tie rod nuts for Style DD have a slot instead of external hex.

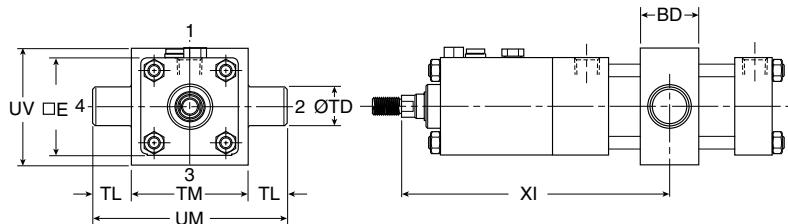
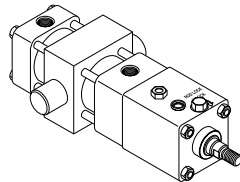

Note: Style DD requires minimum stroke per table.

Style DD

Bore size	Rod no.	Rod dia. MM	E	BD	+0.000 -0.001 TD	TL	TM	UM	UV	Min. XI	Min. stroke
2	1	5/8	2.500	1.500	1.000	1.000	3.000	5.000	3.000	6.00	4.000
	3	1	2.500	1.500	1.000	1.000	3.000	5.000	3.000	7.38	4.000
2-1/2	1	5/8	3.000	1.500	1.000	1.000	3.500	5.500	3.500	5.97	3.875
	3	1	3.000	1.500	1.000	1.000	3.500	5.500	3.500	7.47	3.875
3-1/4	1	1	3.750	2.000	1.000	1.000	4.500	6.500	4.250	13.72	4.375
	3	1-3/8	3.750	2.000	1.000	1.000	4.500	6.500	4.250	14.34	4.375
4	1	1	4.500	2.000	1.000	1.000	5.250	7.250	5.000	14.09	4.875
	3	1-3/8	4.500	2.000	1.000	1.000	5.250	7.250	5.000	14.59	4.875
5	1	1	5.500	2.000	1.000	1.000	6.250	8.250	6.000	16.34	5.125
	3	1-3/8	5.500	2.000	1.000	1.000	6.250	8.250	6.000	16.97	5.125



B
 Tie Rod Cylinders
 Actuator Products
 3MA Series
 4MA/4ML Series
 3MAJ/4MAJ Series
 4MNR Series
 P1D Series

Parker Pneumatic

4MAJ Series

Head Trunnion Mount

Style D (only 4MAJ)
 (NFPA MT1)

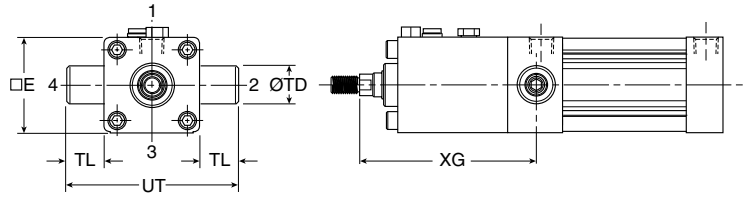
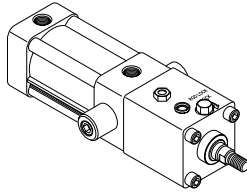

Cap Trunnion Mount

Style DB (only 4MAJ)
 (NFPA MT2)

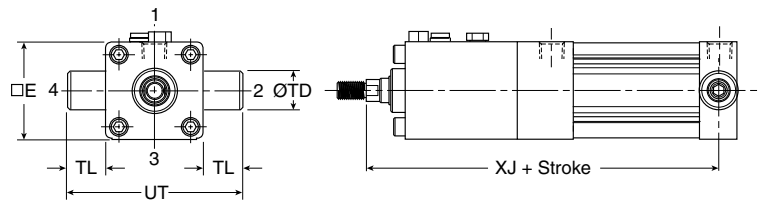
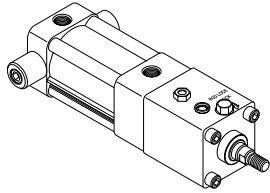

Styles D and DB

Bore size	Rod no.	Rod dia. MM	E	+0.000 -0.001 TD	TL	UT	XG	XJ
1-1/2	1	5/8	2.000	1.000	1.000	4.000	4.375	6.750
	3	1	2.500	1.000	1.000	4.500	4.625	7.000
2	1	5/8	2.500	1.000	1.000	4.500	4.625	7.000
	3	1	2.500	1.000	1.000	4.500	6.000	8.375
2-1/2	1	5/8	3.000	1.000	1.000	5.000	4.625	7.125
	3	1	3.000	1.000	1.000	5.000	6.125	8.625
3-1/4	1	1	3.750	1.000	1.000	5.750	6.750	9.500
	3	1-3/8	3.750	1.000	1.000	5.750	7.375	10.125
4	1	1	4.500	1.000	1.000	6.500	7.125	9.875
	3	1-3/8	4.500	1.000	1.000	6.500	7.625	10.375
5	1	1	5.500	1.000	1.000	7.500	7.625	10.625
	3	1-3/8	5.500	1.000	1.000	7.500	8.250	11.250

B
Tie Rod Cylinders
Actuator Products

Series 3MA
Series 4MA/4ML
Series 3MAJ/4MAJ
Series 4MNR
Series P1D



No Mount
 Style T
 (NFPA MX0)

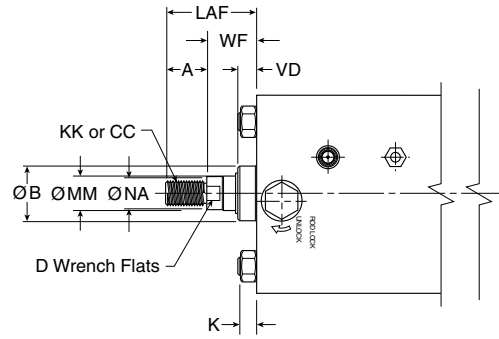
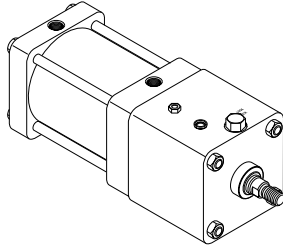

For dimensions of all standard rod end styles, see next page.

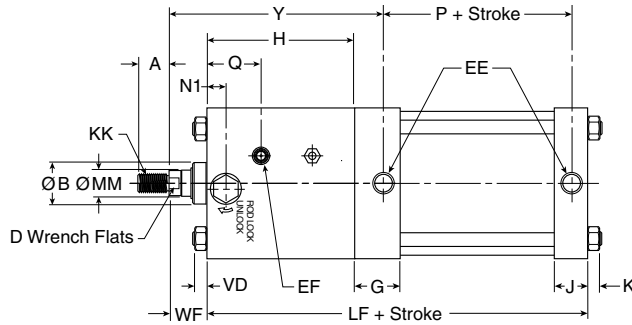
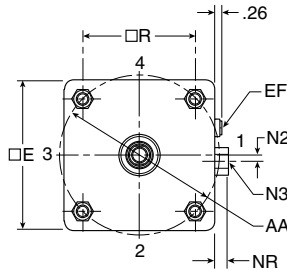

Style T

Bore size	Rod no.	Rod dia. MM	Thread		A	AA	B	D	E	EE (NPTF)	EF (NPTF)	G	H	J
			Style 8 CC	Style 4 & 9 KK										
6	1	1-3/8	1-1/4 - 12	1-14	1.625	6.900	1.999	1-1/8	6.500	3/4	1/4	1.910	6.375	1.410
	3	1-3/4	1-1/2 - 12	1-1/4 - 12	2.000	6.900	2.374	1-1/2	6.500	3/4	1/4	1.910	6.875	1.410
8	1	1-3/8	1-1/4 - 12	1-14	1.625	9.100	1.999	1-1/8	8.500	3/4	1/4	1.810	6.625	1.440
	3	1-3/4	1-1/2 - 12	1-1/4 - 12	2.000	9.100	2.374	1-1/2	8.500	3/4	1/4	1.810	7.125	1.440

Bore size	Rod no.	Rod dia. MM	K	LAF	N1	N2	Hex N3	NA	NR	Q	R	VD	WF	Y	Add stroke	
															LF	P
6	1	1-3/8	0.438	3.250	1.165	0.177	1-5/16	1.313	0.750	2.705	4.880	0.755	1.625	9.188	11.375	3.125
	3	1-3/4	0.438	3.875	1.495	0.177	1-5/16	1.688	0.740	3.055	4.880	0.875	1.875	9.938	11.875	3.125
8	1	1-3/8	0.563	3.250	1.305	0.177	1-5/16	1.313	0.740	2.885	6.440	0.755	1.625	9.375	11.750	3.250
	3	1-3/4	0.563	3.875	1.570	0.177	1-5/16	1.688	0.740	3.145	6.440	0.875	1.875	10.125	12.250	3.250

B

Tie Rod Cylinders
Actuator Products

3MA Series

4MA/4ML Series

3MAJ/4MAJ Series

4MNR Series

P1D Series



Rod End Dimensions – 6" to 8" Bore Sizes

Thread Style 4
 (NFPA Style SM)
 Small Male

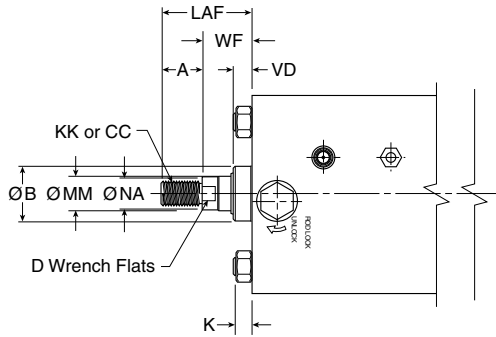

Thread Style 8
 (NFPA Style IM)
 Intermediate Male

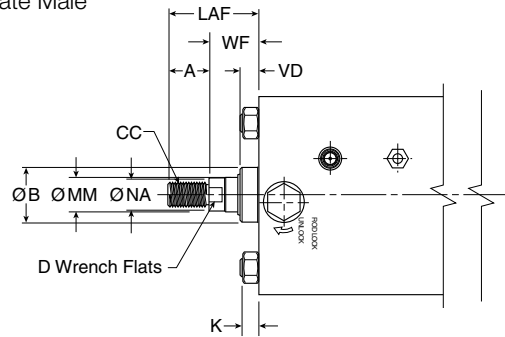

Thread Style 9
 (NFPA Style SF)
 Short Female

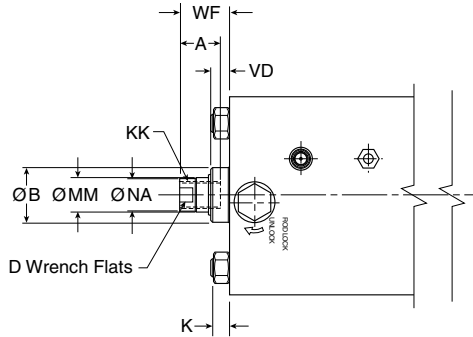

Thread Style 55

For use with Split Coupler
 (please reference catalog 0900P-E, page B105 for more information)

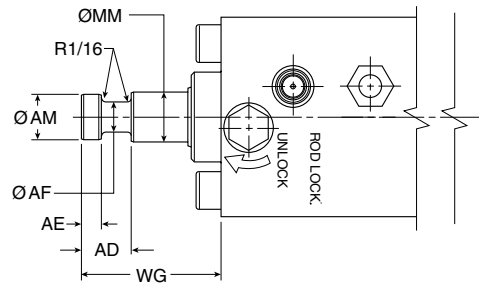

Thread Style 3 - "Special Thread"

Special threads, rod extensions, rod eyes, blanks, etc. are also available.
 To order, specify "Style 3" and give desired dimensions for KK or CC, A and W or WF.
 If otherwise special, please supply dimensioned sketch.

Rod End Dimensions

Bore size	Rod no.	Rod dia. MM	Thread														
			Style 8 CC	Style 4 & 9 KK	A	AD	AE	AF	AM	B	D	K	LAF	NA	VD	WF	WG
6	1	1-3/8	1-1/4-12	1-14	1.625	1.063	0.375	0.875	1.320	1.999	1-1/8	0.438	3.250	1.313	0.755	1.625	2.750
	3	1-3/4	1-1/2-12	1-1/4-12	2.000	1.313	0.500	1.125	1.700	2.374	1-1/2	0.438	3.875	1.688	0.875	1.875	3.125
8	1	1-3/8	1-1/4-12	1-14	1.625	1.063	0.375	0.875	1.320	1.999	1-1/8	0.563	3.250	1.313	0.755	1.625	2.750
	3	1-3/4	1-1/2-12	1-1/4-12	2.000	1.313	0.500	1.125	1.700	2.374	1-1/2	0.563	3.875	1.688	0.875	1.875	3.125

B
 Tie Rod Cylinders
 Actuator Products
 Series
 3MA
 Series
 4MA/4ML
 Series
 3MAJ/4MAJ
 Series
 4MNR
 Series
 P1D
 Series



Head Rectangular Flange Mount

Style J
 (NFPA MF1)
 (only 6" Bore)

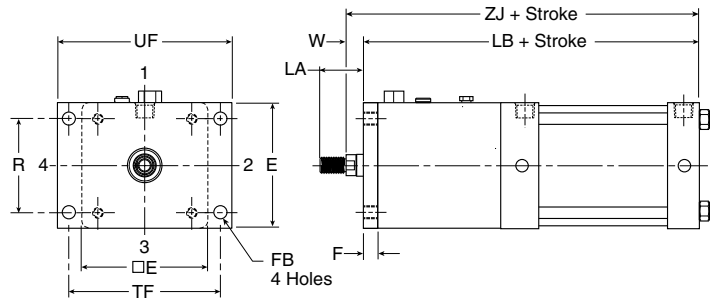
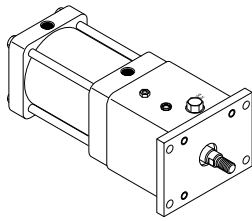

Note: Style J has a W dimension instead of WF and a LA dimension instead of LAF because of the flange installation. Please use dimensions W and LA regarding rod ends only for Style J.
 For reference, $WF = W + F$ and $LA = W + A$.

Cap Rectangular Flange Mount

Style H
 (NFPA MF2)
 (only 6" Bore)

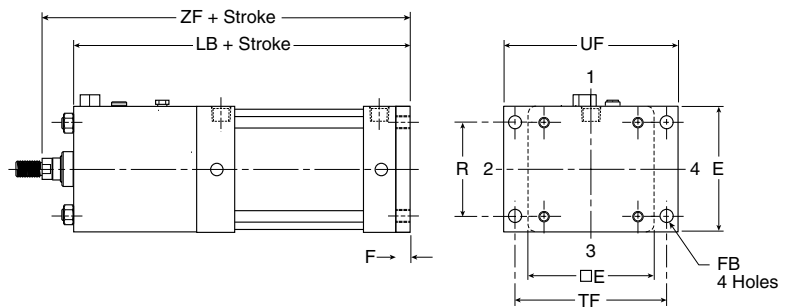
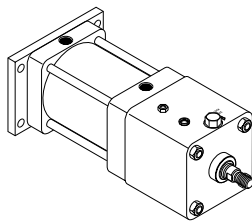

Styles J and H

Bore size	Rod no.	Rod dia. MM	A	E	F	FB	LA	R	TF	UF	W	Add stroke		
												LB	ZF	ZJ
6	1	1-3/8	1.625	6.500	0.750	0.563	2.500	4.880	7.625	8.625	0.875	12.125	13.750	13.000
	3	1-3/4	2.000	6.500	0.750	0.563	3.125	4.880	7.625	8.625	1.125	12.625	14.500	13.750

B

Tie Rod Cylinders
 Actuator Products

3MA Series

4MA/4ML Series

3MAJ/4MAJ Series

4MNR Series

P1D Series

Tie Rods Extended Head End Mount

Style TB
 (NFPA MX3)

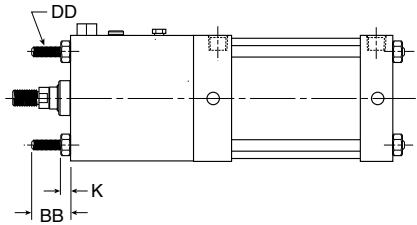
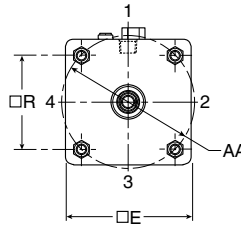
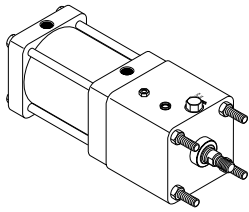

Tie Rods Extended Cap End Mount

Style TC
 (NFPA MX2)

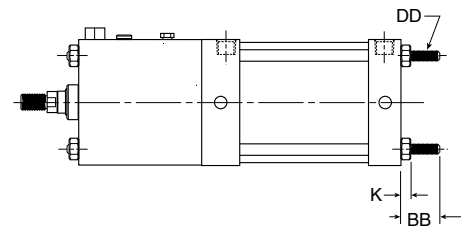
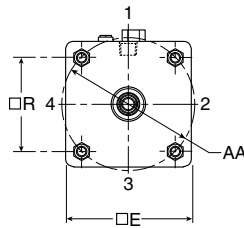
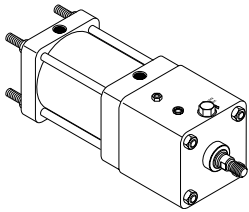

Tie Rods Extended Both Ends Mount

Style TD
 (NFPA MX1)

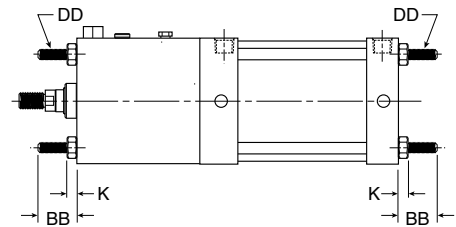
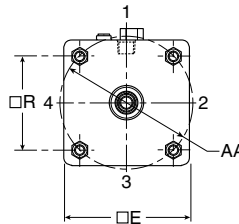
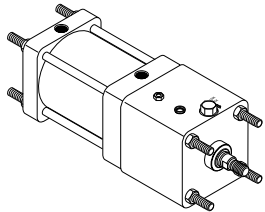

Styles TB, TC and TD

Bore size	Rod no.	Rod dia. MM	AA	BB	DD	E	K	R
6	1	1-3/8	6.900	1.813	1/2-20	6.500	0.438	4.880
	3	1-3/4	6.900	1.813	1/2-20	6.500	0.438	4.880
8	1	1-3/8	9.100	2.313	5/8-18	8.500	0.563	6.440
	3	1-3/4	9.100	2.313	5/8-18	8.500	0.563	6.440

B
 Tie Rod Cylinders
 Actuator Products
 Series
 3MA
 Series
 4MA/4ML
 Series
 3MAJ/4MAJ
 Series
 4MNR
 Series
 P1D
 Series



Parker Pneumatic

3MAJ/4MAJ Series

Side End Angle Mount

Style CB
(NFPA MS1)

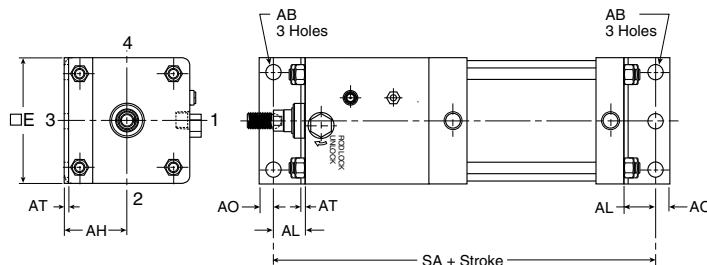
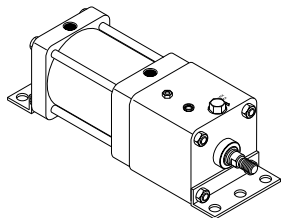

Style CB

Bore size	Rod no.	Rod dia. MM	AB	AH	AL	AO	AT	E	S	Add stroke SA
6	1	1-3/8	0.813	3.250	1.375	0.625	0.188	6.500	5.250	14.125
	3	1-3/4	0.813	3.250	1.375	0.625	0.188	6.500	5.250	14.625
8	1	1-3/8	0.813	4.250	1.813	0.688	0.250	8.500	7.125	15.375
	3	1-3/4	0.813	4.250	1.813	0.688	0.250	8.500	7.125	15.875

Side Tap Mount

Style F
(NFPA MS4)

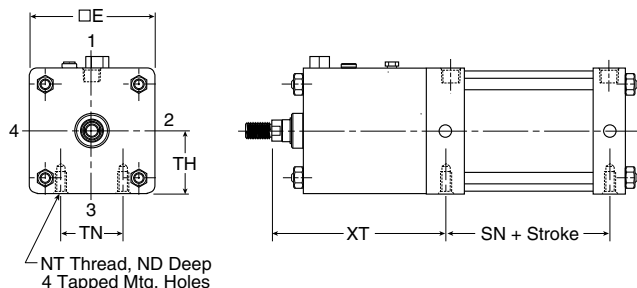
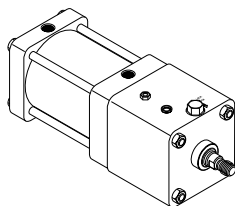

Style F

Bore size	Rod no.	Rod dia. MM	E	ND	NT	+/- .003 TH	TN	XT	Add stroke SN
6	1	1-3/8	6.500	1.125	3/4-10	3.243	3.250	9.188	3.125
	3	1-3/4	6.500	1.125	3/4-10	3.243	3.250	9.938	3.125
8	1	1-3/8	8.500	1.125	3/4-10	4.243	4.500	9.438	3.250
	3	1-3/4	8.500	1.125	3/4-10	4.243	4.500	10.188	3.250

Side Lug Mount

Style C
(NFPA MS2)

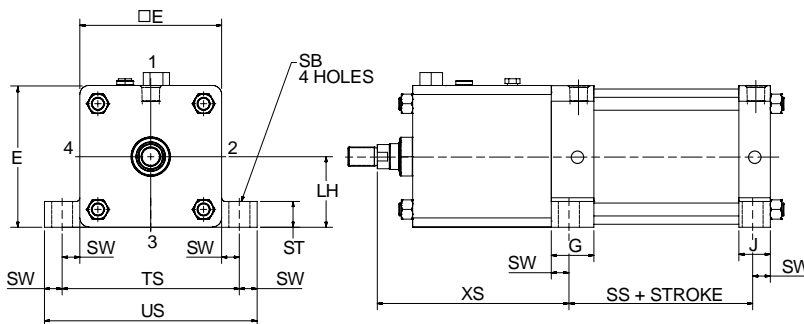
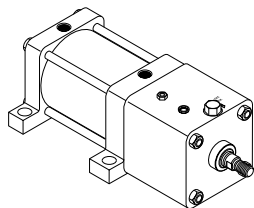

Style C

Bore size	Rod no.	Rod dia. MM	E	G	J	+/- .003 LH	SB	ST	SW	TS	US	XS	Add stroke SS
6	1	1-3/8	6.500	1.910	1.410	3.243	0.813	1.000	0.688	7.875	9.250	8.688	3.625
	3	1-3/4	6.500	1.910	1.410	3.243	0.813	1.000	0.688	7.875	9.250	9.438	3.625
8	1	1-3/8	8.500	1.810	1.440	4.243	0.813	1.000	0.688	9.875	11.250	8.938	3.750
	3	1-3/4	8.500	1.810	1.440	4.243	0.813	1.000	0.688	9.875	11.250	9.688	3.750

B
 Tie Rod Cylinders
 Actuator Products
 3MA Series
 4MA/4ML Series
 3MAJ/4MAJ Series
 4MNR Series
 P1D Series



Parker Pneumatic

3MAJ/4MAJ Series

Cap Fixed Clevis

Style BB
 (NFPA MP1)

NOTE: For maximum swivel angle of BB mount with rear mounting plate, please reference catalog 0900P-E, cylinder accessories on page B108.

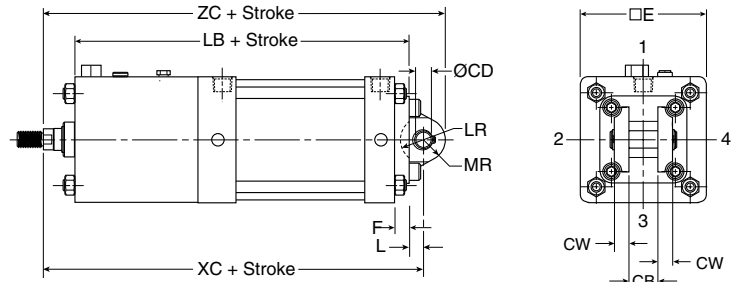
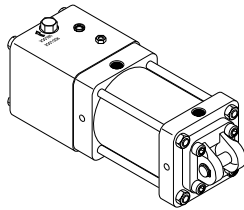

Cap Detachable Clevis

Style BC
 (NFPA MP2)

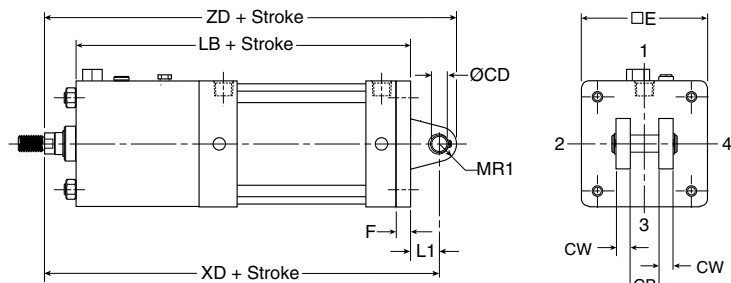
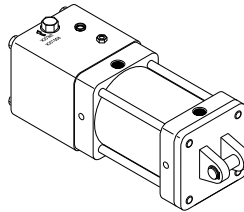

Styles BB and BC

Bore size	Rod no.	Rod dia. MM	CB	Rod dia. +.000 -.002 CD	CW	E	F	L	L1	LR	MR	MR1	Add stroke				
													LB	XC	XD	ZC	ZD
6	1	1-3/8	1.500	1.001	0.750	6.500	0.750	0.750	1.500	1.250	1.125	1.000	12.125	14.500	15.250	15.625	16.250
	3	1-3/4	1.500	1.001	0.750	6.500	0.750	0.750	1.500	1.250	1.125	1.000	12.625	15.250	16.000	16.375	17.000
8	1	1-3/8	1.500	1.001	0.750	8.500	0.750	0.750	1.500	1.250	1.125	1.000	12.500	14.875	15.625	16.000	16.625
	3	1-3/4	1.500	1.001	0.750	8.500	0.750	0.750	1.500	1.250	1.125	1.000	13.000	15.625	16.375	16.750	17.375

Cap Detachable Eye Mount

Style BE
 (NFPA MP4)
 (only 6" Bore)

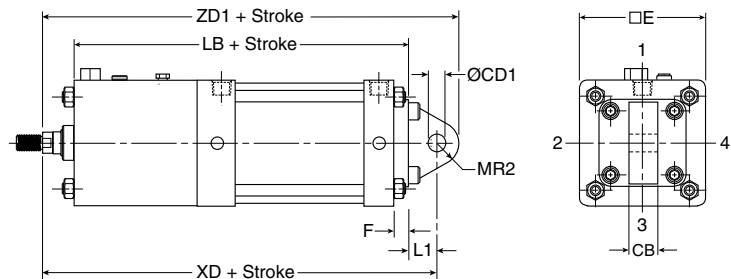
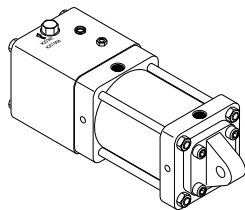

Style BE

Bore size	Rod no.	Rod dia. MM	CB	Rod dia. +.002 +.004 CD1	E	F	L1	MR2	Add stroke		
									LB	XD	ZD1
6	1	1-3/8	1.500	1.000	6.500	0.750	1.500	1.125	12.125	15.250	16.375
	3	1-3/4	1.500	1.000	6.500	0.750	1.500	1.125	12.625	16.000	17.125



B
 Tie Rod Cylinders
 Actuator Products
 Series
 3MA
 Series
 4MA/4ML
 Series
 3MAJ/4MAJ
 Series
 4MNR
 Series
 P1D
 Series

Head Trunnion Mount

Style D
(NFPA MT1)

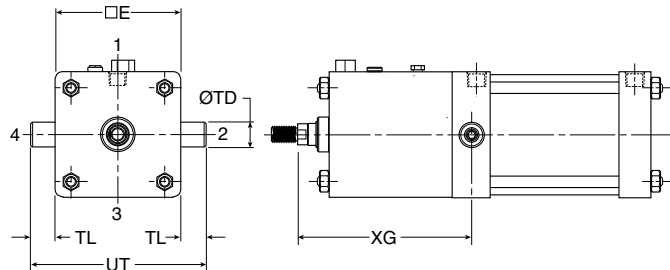
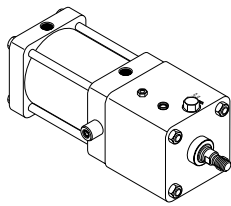

Cap Trunnion Mount

Style DB
(NFPA MT2)

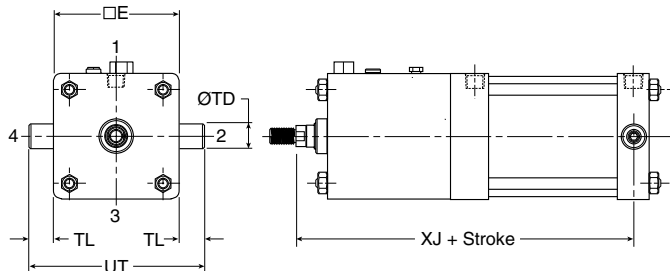
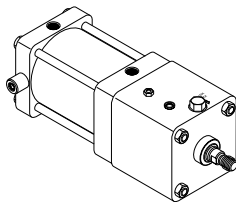

Styles D and DB

Bore size	Rod no.	Rod dia. MM	E	+0.000 -0.001 TD	TL	UT	XG	XJ
6	1	1-3/8	6.500	1.375	1.375	9.250	9.000	12.250
	3	1-3/4	6.500	1.375	1.375	9.250	9.750	13.000
8	1	1-3/8	8.500	1.375	1.375	11.250	9.250	12.625
	3	1-3/4	8.500	1.375	1.375	11.250	10.000	13.375

Intermediate Trunnion Mount

Style DD
(NFPA MT4)

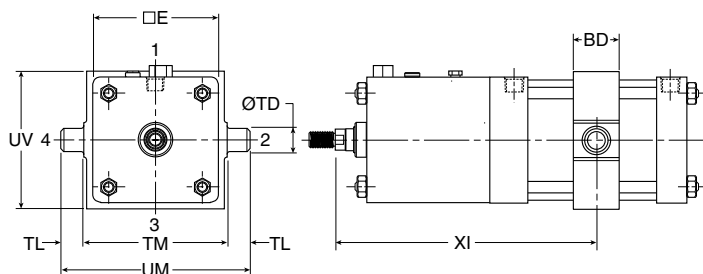
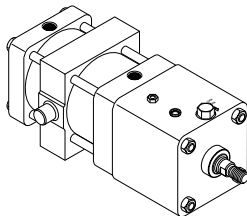

Note: Style DD requires minimum stroke per table.

Style DD

Bore size	Rod no.	Rod dia. MM	E	BD	+0.000 -0.001 TD	TL	TM	UM	UV	Min. XI	Min. stroke
6	1	1-3/8	6.500	2.500	1.375	1.375	7.625	10.375	7.000	20.16	6.125
	3	1-3/4	6.500	2.500	1.375	1.375	7.625	10.375	7.000	20.19	6.125
8	1	1-3/8	8.500	2.500	1.375	1.375	9.750	12.500	9.500	26.31	6.500
	3	1-3/4	8.500	2.500	1.375	1.375	9.750	12.500	9.500	27.06	6.500

Kits & Accessories

See page B37.



B

Tie Rod Cylinders
Actuator Products

3MA Series

4MA/4ML Series

3MAJ/4MAJ Series

4MNR Series

P1D Series

4MNR Series

- Bore sizes – 1-1/8", 1-1/2", 2", 2-1/2", 3-1/4", and 4"
- Non-rotating cylinder, multiple piston rods
- Strokes available in any practical stroke length
- Steel tooling plate standard, specials available
- Single rod end or double rod ends
- Optional adjustable cushions available
- Mounting styles – 14 standard styles
- RoHS compliant

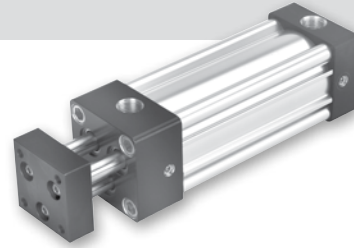

Operating information

Operating pressure:	250 PSIG (17 bar)
Temperature range –	
Standard seals	-10°F to 165°F (-23°C to 74°C)
Fluorocarbon seals	-10°F to 250°F (-23°C to 121°C)
Filtration requirements:	40 micron, dry filtered air

Ordering information

2.00	□	□	J	□	4MNR	2	U	□	□	T	9	□	A	□	6.000
Bore size	Double rod cylinder	Series	Ports	Seals	Tooling plate	Stroke length	Cushion head end	Cylinder construction	Special modification	Blank	Cushion cap end	Piston rod thread type	Rod material and gland code	Piston rod thread style	Piston type ²
1.12 ¹ 1.50 ¹ 2.00 2.50 3.25 4.00	Specify "K" only if double rod cylinder is required.	4MNR	U NPTF R BSPP	Blank Standard (nitrile seals) V Fluorocarbon seals ³ E Fluorocarbon rod wiper and rod seal only ⁴	T Standard plate M Special plate (please specify details)	Specify stroke length required in inches.	Blank Non-cushioned head end C Cushioned head end	Blank* Standard (extruded body, standard round lobe orientation) A* Extruded body, round lobe orientation rotated 90 degrees from standard N* Extruded body, round lobe orientation rotated 180 degrees from standard Z* Extruded body, round lobe orientation rotated 270 degrees from standard T Aluminum round tube and carbon steel tie rods & nuts	Specify "S" only for special modification other than rod end, and then describe modification in item notes. (Includes 4MNR with Linear Position Sensor Option) ⁵	Blank Non-cushioned cap end C Cushioned cap end	Blank Standard (UNF unified thread) A Standard (UNF unified thread)	Blank Standard rod and gland H Standard rod and HI LOAD gland Y 17-4 PH stainless steel rod and standard gland	9 Standard 3 Special (and specify all dimensions required)	2 Lipseals, no magnetic ring (aluminum piston) 3 Lipseals and magnetic ring (aluminum piston)	
	Mounting style														
	Specify mounting style code (see table on following page).														

* Please reference table in catalog 0900P-E, page B10

Kits & Accessories
See page B37.

Sensors
For sensors see page B339.



For ordering purposes, when special options or common modifications are requested, the factory will assign a sequential part number in place of the model number.

4MNR Mounting Styles

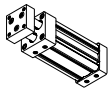
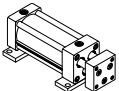
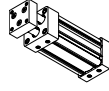
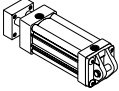
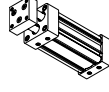
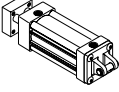
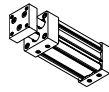
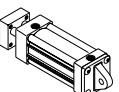
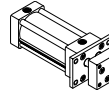
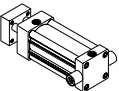
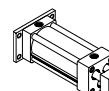
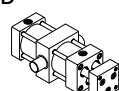
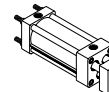
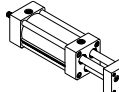
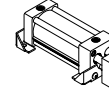
Mounting style	NFPA mounting	Description	Bore size	Mounting style	NFPA mounting	Description	Bore size
TEF 	MX5/MS4	Sleeve Nut with Side Tap (standard mount)	1-1/2 - 4	NB 	N/A	Base Bar	1-1/8 - 4
T 	MX0	No Mount (same construction as TEF)	1-1/8 - 4	BB 	MP1	Cap Fixed Clevis	1-1/2 - 4
TE 	MX5	Sleeve Nut (same construction as TEF)	1-1/2 - 4	BC 	MP2	Cap Detachable Clevis	1-1/8 - 4
F 	MS4	Side Tap (same construction as TEF)	1-1/8 - 4	BE 	MP4	Cap Detachable Eye	1-1/8 - 4
J 	MF1	Head Rectangular Flange	1-1/8 - 4	DB 	MT2	Cap Trunnion	1-1/2 - 4
H 	MF2	Cap Rectangular Flange	1-1/2 - 4	DD 	MT4	Intermediate Trunnion	1-1/2 - 4
TC 	MX2	Tie Rods Extended Cap End	1-1/2 - 5	KTEF / KT / KTE / KF * 	MDX0 / MDX5 / MDS4	Double Rod End	1-1/2 - 4
C 	MS2	Side Lug	1-1/2 - 4				

* Double rod end cylinders can be ordered with head mountings i.e. KJ.

B	Tie Rod Cylinders Actuator Products
3MA Series	
4MA/4ML Series	
3MAJ/4MAJ Series	
4MNR Series	
P1D Series	

4MNR Single Rod Dimensioned Drawings (Styles TEF, T, TE and F)

(NFPA MX0, MX5, MS4)

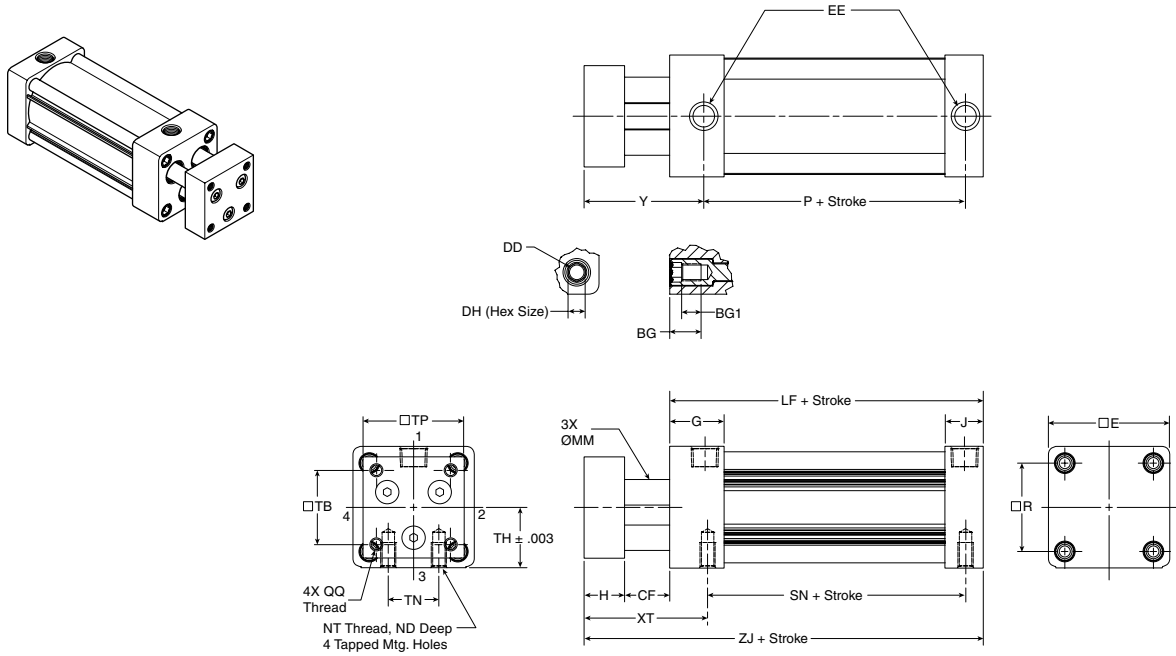

Thread Style 3 - "Special Thread"

Special threads, rod extensions, rod eyes, blanks, etc. are also available.
 To order, specify "Style 3" and give desired dimensions for KK (thread size), A (thread length) and W or WF.
 If otherwise special, please supply dimensioned sketch.

Styles TEF, T, TE and F

Bore size	Rod dia. MM	BG	BG1	CF	DD	DH	E	EE (NPTF)	G	H	J	ND	NT
1-1/8 *	5/16	-	-	0.875	10-32	-	1.500	1/8	1.000	0.625	0.625	0.250	10-32
1-1/2	8mm	0.056	0.375	1.125	1/4-28	1/4	2.000	3/8	1.438	0.750	0.938	0.375	1/4-20
2	12mm	0.056	0.362	1.125	5/16-24	5/16	2.500	3/8	1.375	0.750	0.938	0.438	5/16-18
2-1/2	16mm	0.056	0.362	1.125	5/16-24	5/16	3.000	3/8	1.344	1.000	0.938	0.625	3/8-16
3-1/4	16mm	0.700	0.500	1.375	3/8-24	3/8	3.750	1/2	1.594	1.000	1.125	0.750	1/2-13
4	16mm	0.700	0.500	1.375	3/8-24	3/8	4.500	1/2	1.594	1.000	1.125	0.750	1/2-13

Bore size	Rod dia. MM	QQ	R	TB	TH	TP	TN	XT	Y	Add stroke			
										LF	P	SN	ZJ
1-1/8 *	5/16	6-32	1.125	0.750	0.750	1.250	0.500	2.000	2.031	2.500	1.468	1.500	3.750
1-1/2	8mm	10-32	1.430	1.120	0.993	1.500	0.625	2.812	2.750	3.625	2.313	2.250	5.375
2	12mm	1/4-28	1.840	1.430	1.243	2.000	0.875	2.812	2.750	3.625	2.313	2.250	5.375
2-1/2	16mm	5/16-24	2.190	1.840	1.493	2.500	1.250	3.062	3.062	3.750	2.375	2.375	5.875
3-1/4	16mm	3/8-24	2.760	2.190	1.680	3.250	1.500	3.437	3.437	4.250	2.625	2.625	6.500
4	16mm	3/8-24	3.320	2.760	2.243	4.000	2.063	3.437	3.437	4.250	2.625	2.625	6.500

* Twin rod with flange construction (not shown)

B
 Tie Rod Cylinders
 Actuator Products
 Series
 3MA
 4MA/4ML
 3MAJ/4MAJ
 Series
 4MNR
 Series
 P1D



Head Rectangular Flange

Style J
(NFPA MF1)

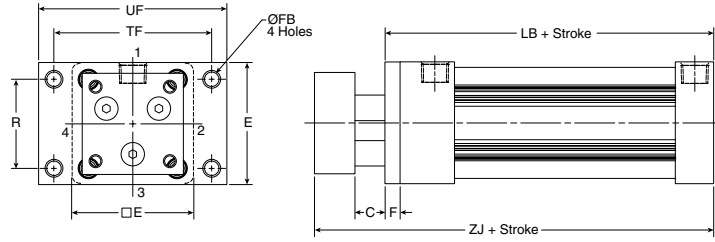
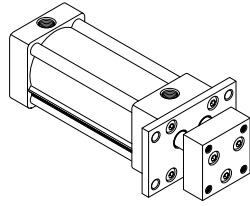

Note: Style J has a "C" dimension instead of "CF" because of the flange installation. For reference, $CF = C + F$

Cap Rectangular Flange

Style H
(NFPA MF2)

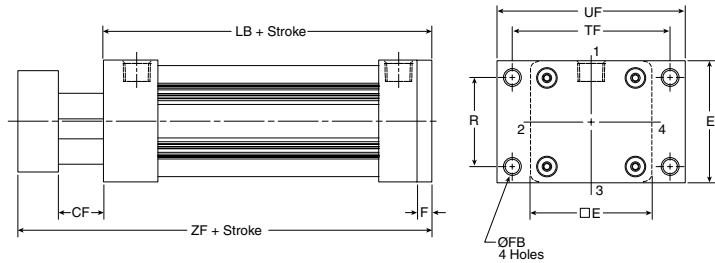
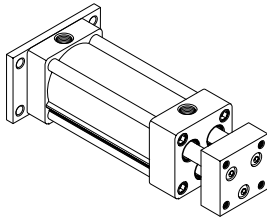

Styles J and H

Bore size	Rod dia. MM	C	CF	E	F	FB	H	R	TF	UF	Add stroke		
											LB	ZF	ZJ
1-1/8 *	5/16	0.625	0.875	1.500	0.250	0.219	0.625	1.000	2.000	2.500	2.750	4.250	4.000
1-1/2	8mm	0.750	1.125	2.000	0.375	0.313	0.750	1.430	2.750	3.375	4.000	5.875	5.500
2	12mm	0.750	1.125	2.500	0.375	0.375	0.750	1.840	3.375	4.125	4.000	5.875	5.500
2-1/2	16mm	0.750	1.125	3.000	0.375	0.375	1.000	2.190	3.875	4.625	4.125	6.250	5.875
3-1/4	16mm	0.750	1.375	3.750	0.625	0.438	1.000	2.760	4.688	5.500	4.875	7.250	6.625
4	16mm	0.750	1.375	4.500	0.625	0.438	1.000	3.320	5.438	6.250	4.875	7.250	6.625

* Twin rod with flange construction (not shown)

Tie Rods Ext. Cap End

Style TC
(NFPA MX2)

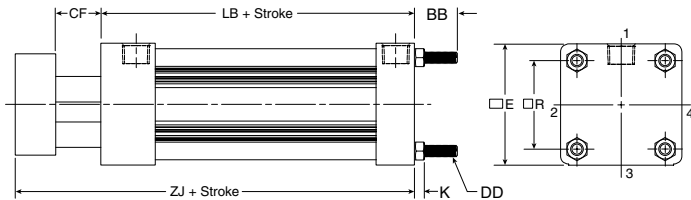
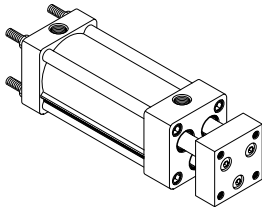

Style TC

Bore size	Rod dia. MM	BB	DD	CF	E	K	R	Add stroke	
								LB	ZJ
1-1/2	8mm	1.000	1/4-28	1.125	2.000	0.250	1.430	4.000	5.500
2	12mm	1.125	5/16-24	1.125	2.500	0.313	1.840	4.000	5.500
2-1/2	16mm	1.125	5/16-24	1.125	3.000	0.313	2.190	4.125	5.875
3-1/4	16mm	1.375	3/8-24	1.375	3.750	0.375	2.760	4.875	6.625
4	16mm	1.375	3/8-24	1.375	4.500	0.375	3.320	4.875	6.625

B

Tie Rod Cylinders
Actuator Products

3MA Series

4MA/4ML Series

3MAJ/4MAJ Series

4MNR Series

P1D Series



Side Lug

Style C
 (NFPA MS2)

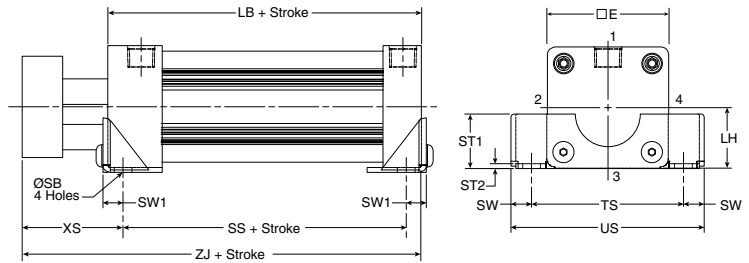
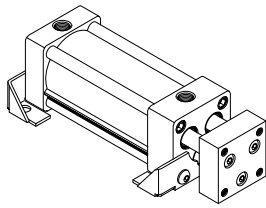

Style C

Bore size	Rod dia. MM	E	LH	SB	ST1	ST2	SW	SW1	TS	US	XS	Add stroke		
												LB	SS	ZJ
1-1/2	8mm	2.000	0.993	0.438	1.000	0.120	0.375	0.495	2.750	3.500	2.250	4.000	2.875	5.500
2	12mm	2.500	1.243	0.438	1.250	0.120	0.375	0.495	3.250	4.000	2.250	4.000	2.875	5.500
2-1/2	16mm	3.000	1.493	0.438	1.343	0.120	0.375	0.495	3.750	4.500	2.500	4.125	3.000	5.875
3-1/4	16mm	3.750	1.868	0.563	1.500	0.188	0.500	0.688	4.750	5.750	2.875	4.875	3.250	6.625
4	16mm	4.500	2.243	0.563	1.500	0.188	0.500	0.688	5.500	6.500	2.875	4.875	3.250	6.625

Base Bar Mount

Style NB

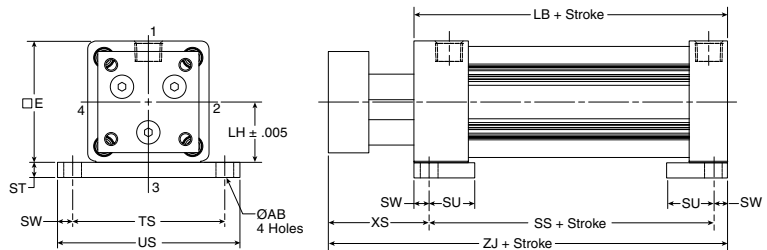
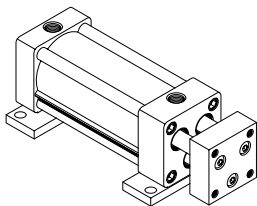

Note: Fasteners for NB base bar mount have been applied with removable threadlocking compound and torqued to bottom of endcaps.

Style NB

Bore size	Rod dia. MM	AB	E	LH	ST	SU	SW	TS	US	XS	Add stroke		
											LB	SS	ZJ
1-1/8 *	5/16	0.203	1.500	1.000	0.250	0.750	0.250	1.875	2.375	1.750	2.750	1.750	3.750
1-1/2	8mm	0.438	2.000	1.243	0.250	1.125	0.375	2.750	3.500	2.250	4.000	2.875	5.500
2	12mm	0.438	2.500	1.493	0.250	1.125	0.375	3.250	4.000	2.250	4.000	2.875	5.500
2-1/2	16mm	0.438	3.000	1.868	0.375	1.125	0.375	3.750	4.500	2.500	4.125	3.000	5.875
3-1/4	16mm	0.563	3.750	2.368	0.500	1.250	0.500	4.750	5.750	2.875	4.875	3.250	6.625
4	16mm	0.563	4.500	2.743	0.500	1.250	0.500	5.500	6.500	2.875	4.875	3.250	6.625

* Twin rod with flange construction (not shown)

Cap Fixed Clevis

Style BB (NFPA MP1)

Note: For maximum swivel angle of BB mount with rear mounting plate, please reference catalog 0900P-E, accessories page B141.

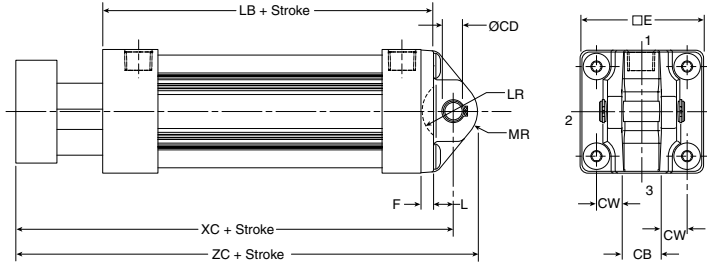
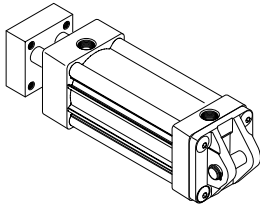

Cap Detachable Clevis

Style BC (NFPA MP2)

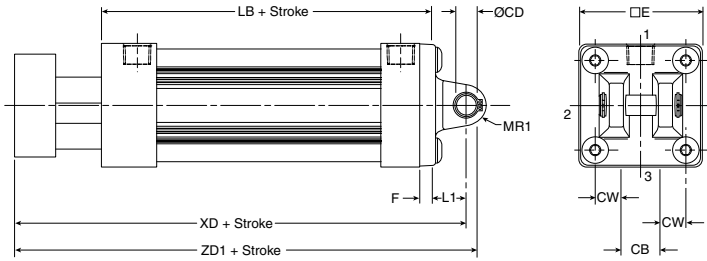
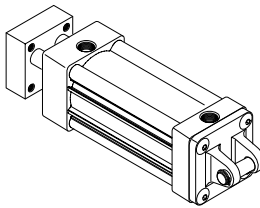

Cap Detachable Eye

Style BE (NFPA MP4)

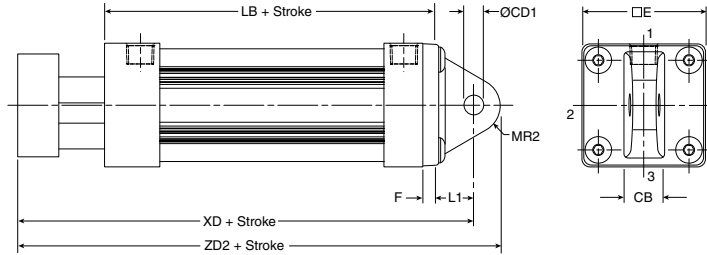
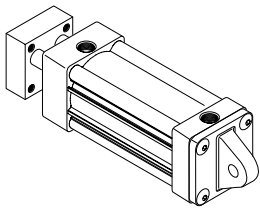

Styles BB, BC and BE

Bore size	Rod dia. MM	CB	CD	CD1	CW	E	F	L	LR	L1
1-1/2	8mm	0.750	0.501	0.500	0.500	2.000	0.375	0.375	0.750	0.750
2	12mm	0.750	0.501	0.500	0.500	2.500	0.375	0.375	0.750	0.750
2-1/2	16mm	0.750	0.501	0.500	0.500	3.000	0.375	0.375	0.750	0.750
3-1/4	16mm	1.250	0.751	0.750	0.625	3.750	0.625	0.625	1.000	1.250
4	16mm	1.250	0.751	0.750	0.625	4.500	0.625	0.625	1.000	1.250

Bore size	Rod dia. MM	MR	MR1	MR2	Add stroke					
					LB	XC	XD	ZC	ZD1	ZD2
1-1/2	8mm	0.625	0.500	0.625	4.000	6.250	6.625	6.875	7.125	7.250
2	12mm	0.625	0.500	0.625	4.000	6.250	6.625	6.875	7.125	7.250
2-1/2	16mm	0.625	0.500	0.688	4.125	6.625	7.000	7.250	7.500	7.688
3-1/4	16mm	0.938	0.750	0.875	4.875	7.875	8.500	8.813	9.250	9.375
4	16mm	0.938	0.750	0.875	4.875	7.875	8.500	8.813	9.250	9.375

B

Tie Rod Cylinders
Actuator Products

3MA Series

4MA/4ML Series

3MAJ/4MAJ Series

4MNR Series

P1D Series



Cap Trunnion

Style DB
(NFFA MT2)

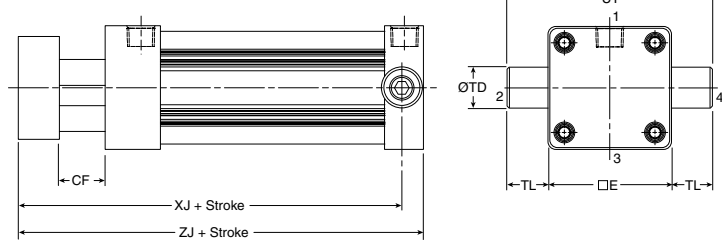
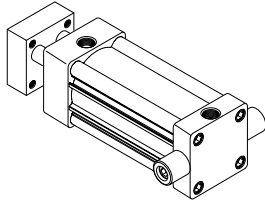

Intermediate Trunnion

Style DD
(NFFA MT4)

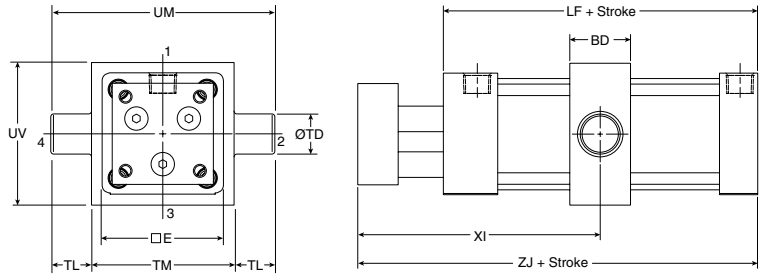
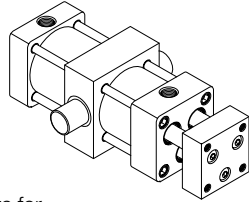

Note: Tie rod nuts for Style DD have a slot instead of internal hex.

Styles DD and DD

Bore size	Rod dia. MM	E	BD	CF	TD	TL	TM	UM	UT	UV	Min. XI	Add stroke		
												LF	XJ	ZJ
1-1/2	8mm	2.000	1.250	1.125	1.000	1.000	2.500	4.500	4.000	2.500	4.000	4.000	5.000	5.875
2	12mm	2.500	1.500	1.125	1.000	1.000	3.000	5.000	4.500	3.000	4.125	4.000	5.000	5.875
2-1/2	16mm	3.000	1.500	1.125	1.000	1.000	3.500	5.500	5.000	3.500	4.375	4.125	5.375	6.250
3-1/4	16mm	3.750	2.000	1.375	1.000	1.000	4.500	6.500	5.750	4.250	5.125	4.875	6.000	7.250
4	16mm	4.500	2.000	1.375	1.000	1.000	5.250	7.250	6.500	5.000	5.125	4.875	6.000	7.250

B
 Tie Rod Cylinders
 Actuator Products
 Series
 3MA
 Series
 4MA/4ML
 Series
 3MAJ/4MAJ
 Series
 4MNR
 Series
 P1D
 Series



P1D Series

The innovative P1D is a long lasting ISO/VDMA cylinder. The cylinders are double acting, with a new design of air cushioning.

The P1D complies with the current ISO 6431, ISO 15552, VDMA 24562 and AFNOR installation dimension standards

- Available in 32 to 200mm bores
- PUR seals for long service life
- Drop-in sensors
- Corrosion resistant design
- Magnetic piston as standard
- Lubricated with food grade grease



Operating information

Operating pressure:	145 PSIG (10 bar) maximum
Temperature range:	Standard: -4°F to 176°F (-20°C to 80°C) High temperature: 14°F to 250°F (-10°C to 121°C)
Cylinders for low pressure hydraulic operation:	Ø32 - 125mm
ATEX approval:	CE Ex IIGD c T4 248°F (120°C)
Filtration requirements:	40 micron, dry filtered air

P1D Standard - Double acting

Ø32mm - (G¹/₈)

Stroke (mm)	Order Code
25	P1D-S032MC-0025NNNNN
40	P1D-S032MC-0040NNNNN
50	P1D-S032MC-0050NNNNN
80	P1D-S032MC-0080NNNNN
100	P1D-S032MC-0100NNNNN
125	P1D-S032MC-0125NNNNN
160	P1D-S032MC-0160NNNNN
200	P1D-S032MC-0200NNNNN
250	P1D-S032MC-0250NNNNN
320	P1D-S032MC-0320NNNNN
400	P1D-S032MC-0400NNNNN
500	P1D-S032MC-0500NNNNN

Ø40mm - (G¹/₄)

25	P1D-S040MC-0025NNNNN
40	P1D-S040MC-0040NNNNN
50	P1D-S040MC-0050NNNNN
80	P1D-S040MC-0080NNNNN
100	P1D-S040MC-0100NNNNN
125	P1D-S040MC-0125NNNNN
160	P1D-S040MC-0160NNNNN
200	P1D-S040MC-0200NNNNN
250	P1D-S040MC-0250NNNNN
320	P1D-S040MC-0320NNNNN
400	P1D-S040MC-0400NNNNN
500	P1D-S040MC-0500NNNNN

Ø50mm - (G¹/₄)

25	P1D-S050MC-0025NNNNN
40	P1D-S050MC-0040NNNNN
50	P1D-S050MC-0050NNNNN
80	P1D-S050MC-0080NNNNN
100	P1D-S050MC-0100NNNNN
125	P1D-S050MC-0125NNNNN
160	P1D-S050MC-0160NNNNN
200	P1D-S050MC-0200NNNNN
250	P1D-S050MC-0250NNNNN
320	P1D-S050MC-0320NNNNN
400	P1D-S050MC-0400NNNNN
500	P1D-S050MC-0500NNNNN

Ø63mm - (G³/₈)

Stroke (mm)	Order Code
25	P1D-S063MC-0025NNNNN
40	P1D-S063MC-0040NNNNN
50	P1D-S063MC-0050NNNNN
80	P1D-S063MC-0080NNNNN
100	P1D-S063MC-0100NNNNN
125	P1D-S063MC-0125NNNNN
160	P1D-S063MC-0160NNNNN
200	P1D-S063MC-0200NNNNN
250	P1D-S063MC-0250NNNNN
320	P1D-S063MC-0320NNNNN
400	P1D-S063MC-0400NNNNN
500	P1D-S063MC-0500NNNNN

Ø80mm - (G³/₈)

25	P1D-S080MC-0025NNNNN
40	P1D-S080MC-0040NNNNN
50	P1D-S080MC-0050NNNNN
80	P1D-S080MC-0080NNNNN
100	P1D-S080MC-0100NNNNN
125	P1D-S080MC-0125NNNNN
160	P1D-S080MC-0160NNNNN
200	P1D-S080MC-0200NNNNN
250	P1D-S080MC-0250NNNNN
320	P1D-S080MC-0320NNNNN
400	P1D-S080MC-0400NNNNN
500	P1D-S080MC-0500NNNNN

Ø100mm - (G¹/₂)

Stroke (mm)	Order Code
25	P1D-S100MC-0025NNNNN
40	P1D-S100MC-0040NNNNN
50	P1D-S100MC-0050NNNNN
80	P1D-S100MC-0080NNNNN
100	P1D-S100MC-0100NNNNN
125	P1D-S100MC-0125NNNNN
160	P1D-S100MC-0160NNNNN
200	P1D-S100MC-0200NNNNN
250	P1D-S100MC-0250NNNNN
320	P1D-S100MC-0320NNNNN
400	P1D-S100MC-0400NNNNN
500	P1D-S100MC-0500NNNNN

Ø125mm - (G¹/₂)

25	P1D-S125MC-0025NNNNN
40	P1D-S125MC-0040NNNNN
50	P1D-S125MC-0050NNNNN
80	P1D-S125MC-0080NNNNN
100	P1D-S125MC-0100NNNNN
125	P1D-S125MC-0125NNNNN
160	P1D-S125MC-0160NNNNN
200	P1D-S125MC-0200NNNNN
250	P1D-S125MC-0250NNNNN
320	P1D-S125MC-0320NNNNN
400	P1D-S125MC-0400NNNNN
500	P1D-S125MC-0500NNNNN

The cylinders are supplied complete with a zinc plated steel piston rod nut.

Sensors

For sensors see page B339.



Most popular.



Design Versions

P1D Basic Version

The P1D Basic Version cylinders meet the specifications in the ISO 15552 standard. This means full interchangeability to any ISO 15552 cylinder anywhere around the globe. P1D Basic Version will be available throughout the extensive worldwide Parker Hannifin organization.



P1D Standard Version

P1D Standard Version cylinders are available in 32-125mm bores and utilize internal composite technology to save weight, while assuring the high performance and functionality expected of ISO cylinders. Cushions and bumpers at both ends and a magnetic piston are included as standard. The Standard Version serves all markets where performance at an affordable price is desired.



P1D Removable Gland Version

P1D Removable Gland Version cylinders are available in 32-200mm bores and utilize bar stock endcaps and a removable high-strength bronze bearing for traditional and custom applications. The bronze bearing assembly is externally removable for quick and easy maintenance. No other ISO cylinder manufacturer in the world produces a Removable Gland Version and meets these demands. This version covers all applications which require performance and customization at all bore sizes.



P1D Rod Lock Cylinder

The P1D Rod Lock Cylinder incorporates a powerful piston rod locking device, which clamps the piston rod and locks it in position. The locking device is a spring lock with an air pressure release and is integrated into the front (head) cover of the cylinder.



P1D Clean Version

The P1D Clean Version is completely designed for the food industry. The stringent requirements for hygiene regarding choice of material and corrosion resistance have guided the development of this cylinder version. Available with BSPP ports (ISO 1179-1 with ISO 228-1 threads).



P1D Tie-Rod Version

The P1D Tie-Rod Version cylinders are based on the same high level technology as the Standard Version. They accept either Standard Version or Removable Gland Version heads and caps. This cylinder is the perfect choice wherever a true tie-rod cylinder is needed.



Guided Cylinders

For guided versions of the P1D, see the P5E Series and HB Series.

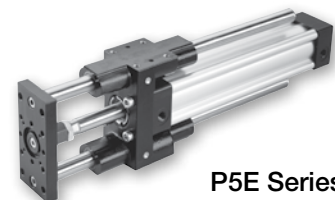

P5E Series

B	Tie Rod Cylinders Actuator Products
	3MA Series
	4MA/4ML Series
	3MAJ/4MAJ Series
	4MNR Series
	P1D Series

Ordering information

P1D	-	S	032	M	C	-	0500	N	N	N	N	N
------------	----------	----------	------------	----------	----------	----------	-------------	----------	----------	----------	----------	----------

Piston Style			Bore size		Stroke ¹⁴		Rod end	
Cushions	Piston material		032	32mm	Specify whole mm using 4 digits, i.e. 0500		N	Metric male
	Composite ¹	Aluminum ²	040	40mm			6	Metric female
None	M	Y	050	50mm			3	Special*
Cush B/E	- 3, 20	4	063	63mm			* Please provide desired dimensions for KK, AM and WH or W. If otherwise, please provide dimensioned sketch.	
Cush head	J	5	080	80mm				
Cush cap	K	6	100	100mm				
			125	125mm				
			160	160mm ⁸				
			200	200mm ⁸				

Version				
	Cylinder body profile	Rod lock		
		None	Fitted w/ standard rod lock ⁷	Fitted w/ manual override rod lock ⁷
Die cast end caps ⁴	Basic	B	N/A	N/A
	Standard	S	L	N/A
	Tie Rod ¹³	T	M	N/A
	Clean	C	D	N/A
Machined end caps rod lock not available with removable gland. ⁵	Standard	G ⁵	R	J
	Tie Rod ¹³	E ⁵	7 ⁴	Consult Factory
Special ⁶	Any Special	/		

Function				
Fastener type	Rod wiper style	Double acting	Double rod	Tandem ¹³
Standard end cover screws	Std scraper	M ²⁰	F	C
	Metal scraper	Q	R	J
Stainless steel end cover screws ⁹	Std scraper	A	G	N/A
	Metal scraper	S	T	N/A

Piston rod & seal material			
Piston rod material	Seal material		
	Standard	Fluorocarbon ¹⁰	Hydraulic ¹¹
Chrome plated carbon steel ²	C ²⁰	G	J
Chrome plated stainless steel ^{2, 19}	R ²⁰	D	Z
303 Stainless steel ¹³	S	N/A	N/A
Acid-resistant stainless steel	M	N ²	N/A

Rod mountings & plugs ¹⁵		
Rod mounting	No plugs ^{16, 20}	With plugs ¹
Swivel rod eye	S	A
Swivel rod eye SS	T	1
Swivel rod eye with clevis bracket GA ¹⁹	V	E
Swivel rod eye SS with clevis bracket GA	W	2
Clevis	C	B
Clevis SS	D	3
Flexco coupling	F	G
One additional piston rod nut	X	P
Stainless steel piston rod nut	Y	4
Acid-resistant nut	Z	5
None (piston rod nut only)	N	R

Cylinder ports front & rear			
-	BSPP Ports (G Threads)**		
E	NPTF Ports*		
Q	BSPT Ports (Rc Threads)**†		

* Not available on clean version.
 † Not available on die cast version.
 ** ISO 1179-1 with ISO 228-1 threads.

Sensors ¹⁷			
Prepared for factory-fitted sensors	Cable location		
	Front or left	Rear or right	Front & rear
P1D clean version	6	7	8
P1D all versions (except Clean) prepared for sensors or clean version without sensor capability ^{18, 20}	N		

Mounting style		
	Standard ²⁰	Rotated 90°
Flange MF1 at head (front) end	1	3
Flange MF2 at cap (rear) end	B	4
Flanges MF1 and MF2 at both ends	2	K
Foot brackets MS1	F	R
Clevis bracket GA aluminum	C	U
Rear eye MP4 aluminum	E	V
Rear swivel eye MP6 aluminum	S	W
Clevis bracket MP2 aluminum	T	Y
Rear eye + clevis (MP4 + MP2) aluminum	L	Z
Clevis bracket MP2 + pivot hinge aluminum	X	5
Clevis bracket GA aluminum + steel swivel hinge	Q	0
Rear swivel eye + clevis bracket GA aluminum	M	A
Intermediate trunnion MT4 (requires XV dimension)	G	7
Trunnion flange at head (front) end ⁴	H	P
Trunnion flange at cap (rear) end ⁴	J	8
None (MX0)	N	9

Notes:

- Not available for 160-200mm bores.
- Not available on Clean Version.
- Must be placed in model code.
- Not available for 160-200mm bores or with fluorocarbon seals.
- When Removable Gland Version is fitted with rod lock, gland cannot be replaced without disassembling cylinder.
- If special cylinder is ordered (other than rod end), End Cap Style, Cylinder Body Profile and Rod Lock option must be given in addition to the special request.
- Cylinders fitted with rod locks must be cushioned on both ends.
- Tie Rod Version E must be specified for these bores.
- Applies only to end cover screws for 32-125mm bores. For stainless steel tie rods and nuts (all bore sizes), change Version to special and request stainless steel tie rods and nuts.
- If used for temperature above 80°C (176°F), aluminum piston required. Not available with die cast end caps.
- Hydraulic seal option valid for Removable Gland Version only. Adjustable cushion options and Rod Lock Versions not available.
- Only available on Clean Version.
- Tie Rod Version is required for Tandem Function.
- When specifying a stop tube, place a "/" in the version field. Then specify the version, amount of stop tube and amount of net stroke. The stroke used in the model code should be gross stroke (net stroke plus stop tube).
- Please review Piston Rod Selection Chart in the Engineering Section to check for a rod buckling condition.
- Clean Version comes standard with plugs. Use this column when ordering Clean Version.
- For sensor part numbers and specifications, please refer to Electronic Sensors section.
- P1D Clean Version ordered without sensors cannot be retrofitted with sensor capability.
- Consult factory for this option.
- Only option for Basic Version.

Double Rod Cylinders
 Double rod option is available with Mounting Styles MX0, MS1, MF1, MF2 and MT4.
 For double rod cylinders, it is assumed that the rod number and rod end are the same for both piston rods. On a double rod cylinder where the two rod ends are different, use a rod end of '3' and be sure to clearly state which rod end is to be assembled at which end.

B

Tie Rod Cylinders
Actuator Products

3MA Series

4MA/4ML Series

3MAJ/4MAJ Series

4MNR Series

P1D Series

For ordering purposes, when special options or common modifications are requested, the factory will assign a sequential part number in place of the model number.



P1D Basic & Standard Version

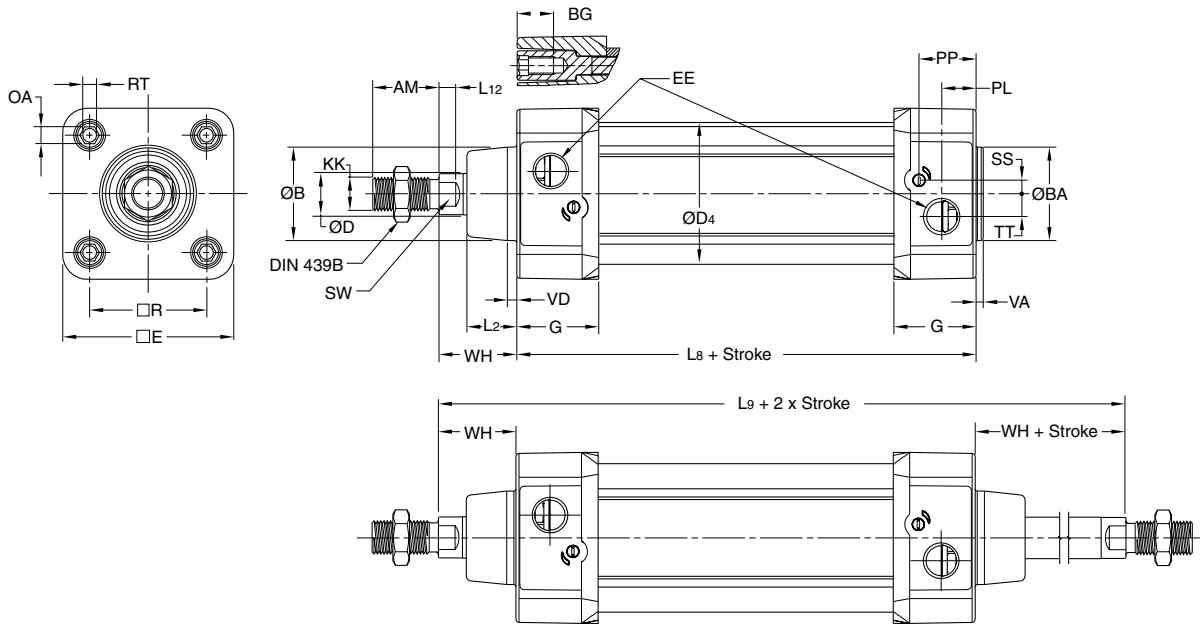

Series	EE															
	Bore size	AM mm	B mm	BA mm	BG mm	D mm	D4 mm	E	BSPP*	NPTF/BSPT	G mm	KK	L2 mm	L8 mm	L9 mm	L12 mm
3MA Series	32	22	30	30	16	12	45.0	50.0	G1/8	1/8	28.5	M10x1.25	16.0	94	146	6.0
	40	24	35	35	16	16	52.0	57.4	G1/4	1/4	33.0	M12x1.25	19.0	105	165	6.5
4MA/4ML Series	50	32	40	40	16	20	60.7	69.4	G1/4	1/4	33.5	M16x1.5	24.0	106	180	8.0
	63	32	45	45	16	20	71.5	82.4	G3/8	3/8	39.5	M16x1.5	24.0	121	195	8.0
	80	40	45	45	17	25	86.7	99.4	G3/8	3/8	39.5	M20x1.5	30.0	128	220	10.0
3MAJ/4MAJ Series	100	40	55	55	17	25	106.7	116.0	G1/2	1/2	44.5	M20x1.5	32.4	138	240	10.0
	125	54	60	60	20	32	134.0	139.0	G1/2	1/2	51.0	M27x2	45.0	160	290	13.0
Series	Bore size	OA mm	PL mm	PP mm	R mm	RT	SS mm	SW mm	TT mm	VA mm	VD mm	WH mm				
	4MNR Series	32	6	13	21.8	32.5	M6	4.0	10	4.5	3.5	4.5	26			
P1D Series	40	6	14	21.9	38.0	M6	8.0	13	5.5	3.5	4.5	30				
	50	8	14	25.9	46.5	M8	4.0	17	7.5	3.5	4.5	37				
P1D Series	63	8	16	27.4	56.5	M8	6.5	17	11.0	3.5	4.5	37				
	80	6	16	30.5	72.0	M10	0	22	15.0	3.5	4.5	46				
	100	6	18	35.8	89.0	M10	0	22	20.0	3.5	4.5	51				
P1D Series	125	8	23	40.5	110.0	M12	0	27	17.5	3.5	6.5	65				

* ISO 1179-1 with ISO 228-1 threads

P1D Removable Gland Version

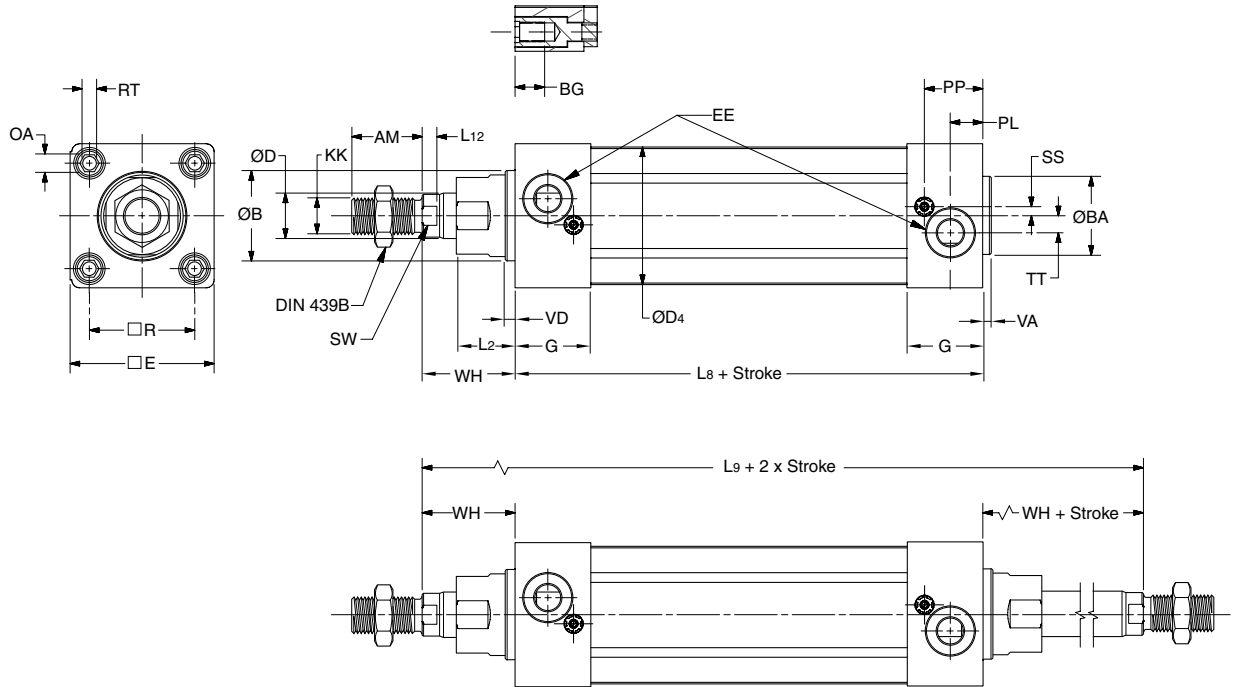

Bore size	AM mm	B mm	BA mm	BG mm	D mm	D4 mm	E mm	EE		G mm	KK	L2 mm	L8 mm	L9 mm	L12 mm
								BSPP *	NPTF/BSPT						
32	22	30	30	16	12	45.0	46.5	G1/8	1/8	28.5	M10x1.25	18	94	146	6.0
40	24	35	35	16	16	52.0	52.0	G1/4	1/4	33.0	M12x1.25	20	105	165	6.5
50	32	40	40	16	20	60.7	63.5	G1/4	1/4	33.5	M16x1.5	26	106	180	6.5
63	32	45	45	16	20	71.5	76.0	G3/8	3/8	39.5	M16x1.5	26	121	195	6.5
80	40	45	45	17	25	86.7	95.5	G3/8	3/8	39.5	M20x1.5	33	128	220	10.0
100	40	55	55	17	25	106.7	114.5	G1/2	1/2	44.5	M20x1.5	33	138	240	10.0
125	54	60	60	20	32	134.0	140.0	G1/2	1/2	51.0	M27x2	41	160	290	13.0

Bore size	OA mm	PL mm	PP mm	R mm	RT	SS mm	SW mm	TT mm	VA mm	VD mm	WH mm
32	6	13	21.8	32.5	M6	6.5	10	4.5	3.5	4.5	26
40	6	14	21.9	38.0	M6	8.0	13	5.5	3.5	4.5	30
50	8	14	25.9	46.5	M8	4.0	17	7.5	3.5	4.5	37
63	8	16	27.4	56.5	M8	6.5	17	11.0	3.5	4.5	37
80	6	16	30.5	72.0	M10	0	22	15.0	3.5	4.5	46
100	6	18	35.8	89.0	M10	0	22	20.0	3.5	4.5	51
125	8	23	40.5	110.0	M12	0	27	17.5	5.5	6.5	65

* ISO 1179-1 with ISO 228-1 threads

B
 Tie Rod Cylinders
 Actuator Products
 3MA Series
 4MA/4ML Series
 3MAJ/4MAJ Series
 4MNR Series
 P1D Series



P1D Rod Lock Version (Version R or L)

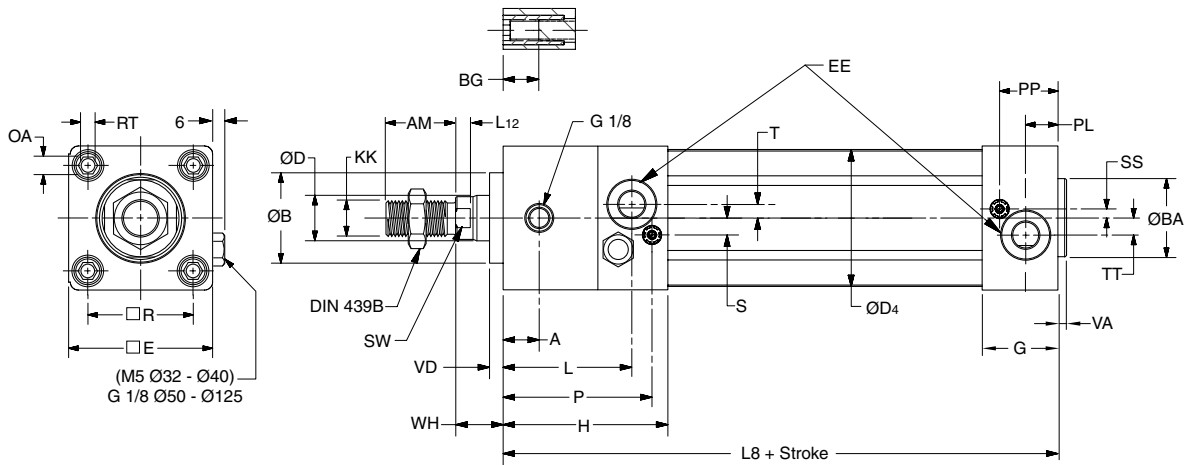

Bore size	A mm	AM mm	B mm	BA mm	BG mm	D mm	D4 mm	E mm	EE *	G mm	H mm	KK	L mm	L8 mm	L12 mm
32	16	22	30	30	16	12	45.0	46.5	G1/8	28.5	71.5	M10x1.25	56.0	137	6.0
40	16	24	35	35	16	16	52.0	52.0	G1/4	33.0	77.0	M12x1.25	56.0	149	6.5
50	18	32	40	40	16	20	60.7	63.5	G1/4	33.5	80.5	M16x1.5	62.5	153	6.5
63	26	32	45	45	16	20	71.5	76.0	G3/8	39.5	96.5	M16x1.5	74.5	178	6.5
80	35	40	45	45	17	25	86.7	95.5	G3/8	39.5	110.5	M20x1.5	87.0	199	10.0
100	50	40	55	55	17	25	106.7	114.5	G1/2	44.5	132.5	M20x1.5	106.0	226	10.0
125	60	54	60	60	20	32	134.0	140.0	G1/2	51.0	145.0	M27x2	117.0	254	13.0

Bore size	OA mm	P mm	PL mm	PP mm	R mm	RT mm	S mm	SS mm	SW mm	T mm	TT mm	VA mm	VD mm	WH mm
32	6	64.8	13	21.8	32.5	M6	7	6.5	10	2.5	4.5	3.5	4.5	15
40	6	68.0	14	21.9	38.0	M6	9	8.0	13	2.0	5.5	3.5	4.5	16
50	8	73.5	14	25.9	46.5	M8	8	4.0	17	4.0	7.5	3.5	5.0	17
63	8	89.5	16	27.4	56.5	M8	8	6.5	17	2.0	11.0	3.5	5.0	17
80	6	101.5	16	30.5	72.0	M10	9	0	22	5.0	15.0	3.5	4.0	20
100	6	123.5	18	35.8	89.0	M10	12	0	22	6.0	20.0	3.5	4.0	20
125	8	136.0	23	40.5	110.0	M12	12	0	27	6.0	17.5	5.5	6.0	27

* ISO 1179-1 with ISO 228-1 threads

B
 Tie Rod Cylinders
 Actuator Products
 Series
 3MA
 4MA/4ML
 3MAJ/4MAJ
 4MNR
 P1D



P1D Tie-Rod Version (32-125mm)

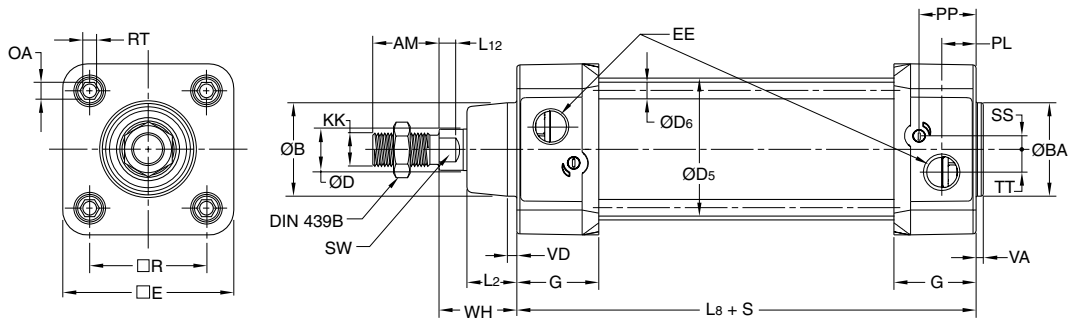

P1D Clean Version

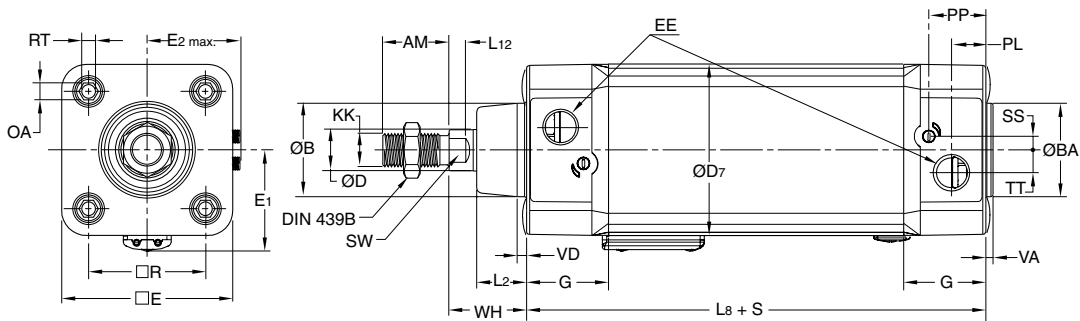

Bore size	D5 mm	D6 mm	D7 mm	E1 mm	E2 max mm
32	36	5.3	49.6	32	5
40	45	5.3	57.3	36	6
50	55	7.1	69.3	42	6
63	68	7.1	82.3	49	5
80	85	8.9	99.3	57	5
100	105	8.9	117.6	68	6
125	132	10.7	142.8	81	6

Other dimensions, see P1D removable gland version.

B

Tie Rod Cylinders
Actuator Products

3MA Series

4MA/4ML Series

3MAJ/4MAJ Series

4MNR Series

P1D Series

P1D Tie-Rod Version (160-200mm)

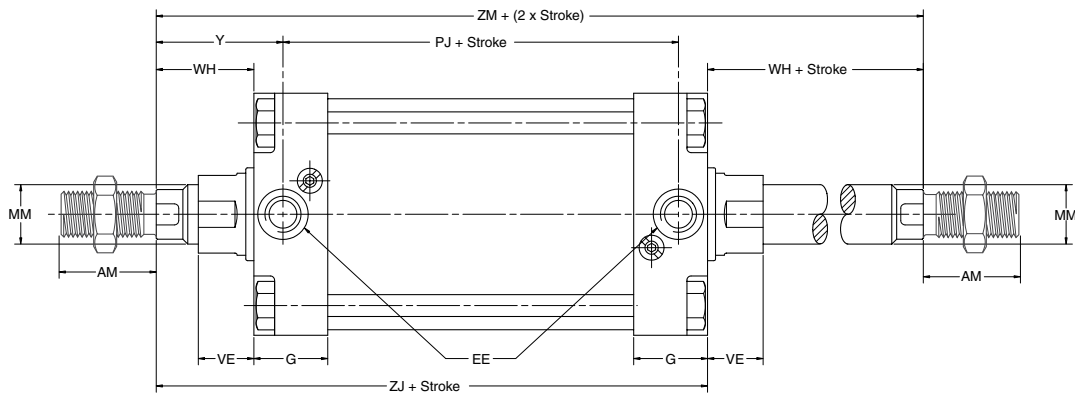
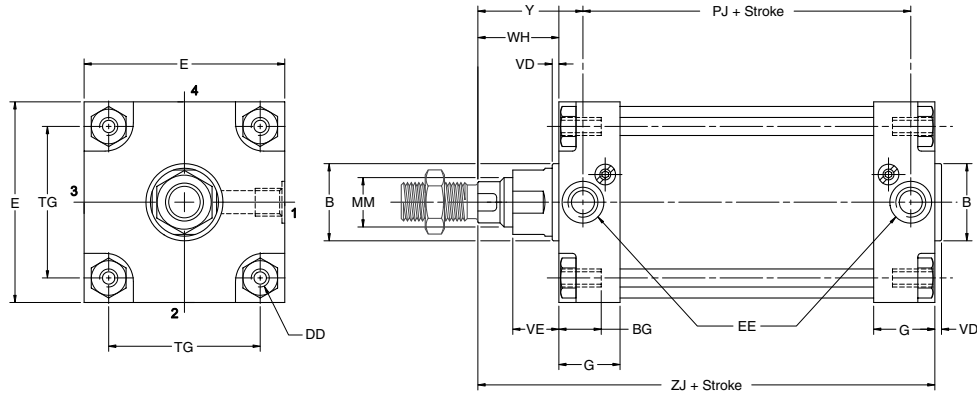

Rod End #1

Rod End #2

Bore size	AM mm	B d11 mm	BG mm	DD	E mm	EE		G mm	MM mm	TG mm	VD mm	VE mm	WH mm	Y mm	PJ1 mm	ZJ1 mm	ZM2 mm
						BSPP ³	NPTF/BSPT										
160	72	65	24	M16	177	G3/4	3/4	54	40	140	6	56	80	105	130	260	340
200	72	75	24	M16	214	G3/4	3/4	54	40	175	6	56	95	120	130	275	370

1 Add stroke
 2 Add 2x stroke
 3 ISO 1179-1 with ISO 228-1 threads

Double Rod Cylinders

Double rod option is available on Mounting Styles MX0, MS1, MF1, MF2 and MT4.

For double rod cylinders, it is assumed that the rod number and rod end are the same for both piston rods. On a double rod cylinder where the two rod ends are different, use a rod end of '3' and be sure to clearly state which rod end is to be assembled at which end.

B
 Tie Rod Cylinders
 Actuator Products
 Series
 3MA
 Series
 4MA/4ML
 Series
 3MAJ/4MAJ
 Series
 4MNR
 Series
 P1D



All Mountings Except MF1

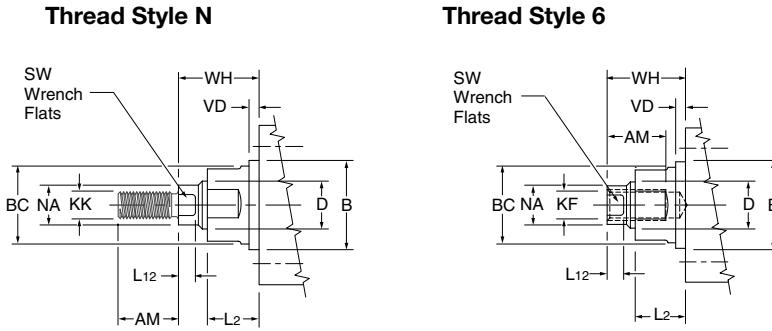

Thread Style 3 - "Special Thread"

Special thread, extension, rod eye, blank, etc are also available. To order, specify "Style 3" and provide desired dimensions for KF or KK, AM and WH. If otherwise special, furnish dimensioned sketch.

Bore size	D	KK	KF	AM	B d11	BC	SW across flats	L12	NA	VD	L2	WH*
32	12	M10x1.25	M8x1	22	30	27	10	6	11	4.5	18	26
40	16	M12x1.25	M10x1.25	24	35	32	13	6.5	15	4.5	20	30
50	20	M16x1.5	M14x1.5	32	40	36	17	6.5	19	4.5	26	37
63	20	M16x1.5	M14x1.5	32	45	36	17	6.5	19	4.5	26	37
80	25	M20x1.5	M18x1.5	40	45	41	22	10	24	4.5	33	46
100	25	M20x1.5	M18x1.5	40	55	41	22	10	24	4.5	33	51
125	32	M27x2	M24x2	54	60	50	27	13	31	6.5	41	65
160	40	M36x2	M30x2	72	65	60	36	16	39	6	56	80
200	40	M36x2	M30x2	72	75	60	36	16	39	6	56	95

*NOTE: Dimensions do not apply to Rod Lock Versions.

With MF1 Mounting

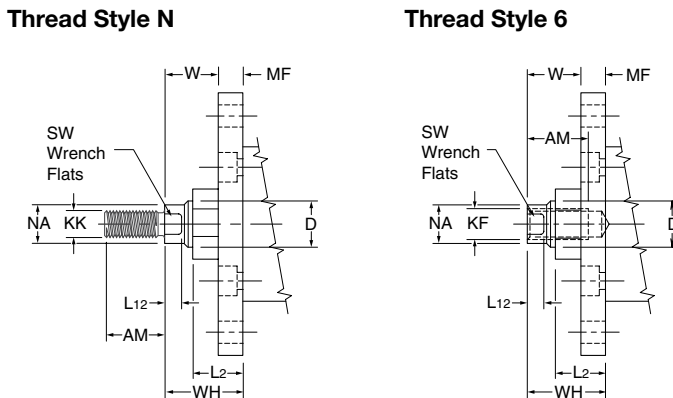

"Special Thread" Style 3

Special thread, extension, rod eye, blank, etc are also available. To order, specify "Style 3" and provide desired dimensions for KF or KK, AM and WH. If otherwise special, furnish dimensioned sketch.

Bore size	D	KK	KF	AM	SW across flats	L12	MF	NA	L2	W†	WH†
32	12	M10x1.25	M8x1	22	10	6	10	11	18	16	26
40	16	M12x1.25	M10x1.25	24	13	6.5	10	15	20	20	30
50	20	M16x1.5	M14x1.5	32	17	6.5	12	19	26	25	37
63	20	M16x1.5	M14x1.5	32	17	6.5	12	19	26	25	37
80	25	M20x1.5	M18x1.5	40	22	10	16	24	33	30	46
100	25	M20x1.5	M18x1.5	40	22	10	16	24	33	35	51
125	32	M27x2	M24x2	54	27	13	20	31	41	45	65
160	40	M36x2	M30x2	72	36	16	20	39	56	60	80
200	40	M36x2	M30x2	72	36	16	25	39	56	70	95

†NOTE: Dimensions do not apply to Rod Lock Versions.

B
 Tie Rod Cylinders
 Actuator Products
 3MA Series
 4MA/4ML Series
 3MAJ/4MAJ Series
 4MNR Series
 P1D Series



Flange – MF1, MF2



Intended for fixed mounting of cylinder. Flange can be fitted to front or rear end cover of cylinder.

Materials:

32-100mm bore flange: Surface-treated aluminum, black
 125-200mm bore flange: Steel, black
 Mounting screws acc. to DIN 6912: Zinc-plated steel 8.8

Supplied complete with mounting screws for attachment to cylinder.

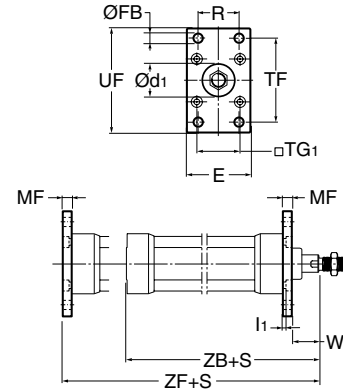

According to ISO MF1/MF2, VDMA 24 562, AFNOR

Bore size mm	d1 H11 mm	FB H13 mm	TG1 mm	E mm	R JS14 mm	MF JS14 mm	TF JS14 mm	UF	l1 -0.5 mm	W mm	ZF mm	ZB mm	Weight kg	Part number
32	30	7	32.5	45	32	10	64	80	5.0	16	130	123.5	0.23	P1C-4KMBA
40	35	9	38.0	52	36	10	72	90	5.0	20	145	138.5	0.28	P1C-4LMBA
50	40	9	46.5	65	45	12	90	110	6.5	25	155	146.5	0.53	P1C-4MMBA
63	45	9	56.5	75	50	12	100	120	6.5	25	170	161.5	0.71	P1C-4NMBA
80	45	12	72.0	95	63	16	126	150	8.0	30	190	177.5	1.59	P1C-4PMBA
100	55	14	89.0	112	75	16	150	185	8.0	35	205	192.5	2.19	P1C-4QMBA
125	60	16	110.0	140	90	20	188	220	10.5	45	245	230.5	3.78	P1C-4RMB
160	65	18	140.0	180	115	20	230	260	9.5	60	280	266	C.F.	L075370160
200	75	22	175.0	220	135	25	270	300	12.5	70	300	281	C.F.	L075370200

S = Stroke length C.F. = Consult Factory

Foot Bracket – MS1



Intended for fixed mounting of cylinder. Foot bracket can be fitted to front and rear end covers of cylinder.

Materials:

Foot bracket: Surface-treated steel, black
 Mounting screws acc. to DIN 912: Zinc-plated steel 8.8

Supplied in pairs with mounting screws for attachment to cylinder.

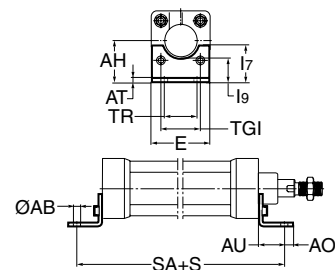

According to ISO MS1, VDMA 24 562, AFNOR

Bore size mm	AB H14 mm	TG1 mm	E mm	TR JS14 mm	AO mm	AU mm	AH JS15 mm	l7 mm	AT mm	l9 JS14 mm	SA mm	Weight* kg	Part number
32	7	32.5	45	32	10	24	32	30	4.5	17.0	142	0.06	P1C-4KMF
40	9	38.0	52	36	8	28	36	30	4.5	18.5	161	0.08	P1C-4LMF
50	9	46.5	65	45	13	32	45	36	5.5	25.0	170	0.16	P1C-4MMF
63	9	56.5	75	50	13	32	50	35	5.5	27.5	185	0.25	P1C-4NMF
80	12	72.0	95	63	14	41	63	49	6.5	40.5	210	0.50	P1C-4PMF
100	14	89.0	115	75	15	41	71	54	6.5	43.5	220	0.85	P1C-4QMF
125	16	110.0	140	90	22	45	90	71	8.0	60.0	250	1.48	P1C-4RMF
160	18	140.0	180	115	15	60	115	100	9.0	63.5	300	C.F.	L075380160
200	22	175.0	220	135	30	70	135	100	12.0	65.0	320	C.F.	L075380200

S = Stroke length C.F. = Consult Factory

*Weight per item



Pivot Bracket with Rigid Bearing



Intended for flexible mounting of cylinder. The pivot bracket can be combined with clevis bracket MP2.

Materials:

Pivot bracket: Surface-treated aluminium, black
 Bearing: Sintered oil-bronze bushing

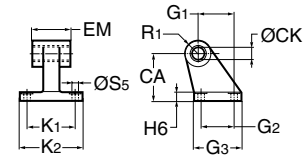

According to CETOP RP 107 P, VDMA 24 562, AFNOR

Bore size mm	CK H9 mm	S5 H13 mm	K1 JS14 mm	K2	G1 JS14 mm	G2 JS14 mm	EM mm	G3 mm	CA JS15 mm	H6 mm	R1 mm	Weight kg	Part number
32	10	6.6	38	51	21	18	25.5	31	32	8	10.0	0.06	P1C-4KMD
40	12	6.6	41	54	24	22	27.0	35	36	10	11.0	0.08	P1C-4LMD
50	12	9.0	50	65	33	30	31.0	45	45	12	13.0	0.15	P1C-4MMD
63	16	9.0	52	67	37	35	39.0	50	50	12	15.0	0.20	P1C-4NMD
80	16	11.0	66	86	47	40	49.0	60	63	14	15.0	0.33	P1C-4PMD
100	20	11.0	76	96	55	50	59.0	70	71	15	19.0	0.49	P1C-4QMD
125	25	14.0	94	124	70	60	69.0	90	90	20	22.5	1.02	P1C-4RMD
160	30	14.0	118	156	97	89	88.5	126	115	25	31.0	C.F.	L075480160
200	30	16.0	122	162	105	89	88.5	130	135	30	31.0	C.F.	L075480200

C.F. = Consult Factory

Swivel Eye Bracket – MP6



Intended for use together with clevis bracket GA

Materials:

Bracket: Surface-treated aluminium, black
 (Cast iron for 160-200mm bores)
 Swivel bearing acc. to DIN 648K: Hardened steel

Supplied complete with mounting screws for attachment to cylinder.

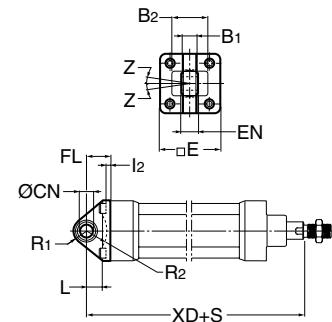

According to VDMA 24 562, AFNOR

Bore size mm	E mm	B1 mm	B2 mm	EN mm	R1 mm	R2 mm	FL mm	l2 mm	L mm	CN H7 mm	XD mm	Z	Weight kg	Part number
32	45	10.5	–	14	16	–	22	5.5	12	10	142	4°	0.08	P1C-4KMSA
40	52	12.0	–	16	18	–	25	5.5	15	12	160	4°	0.11	P1C-4LMSA
50	65	15.0	51	21	21	19	27	6.5	15	16	170	4°	0.20	P1C-4MMSA
63	75	15.0	–	21	23	–	32	6.5	20	16	190	4°	0.27	P1C-4NMSA
80	95	18.0	–	25	29	–	36	10.0	20	20	210	4°	0.52	P1C-4PMSA
100	115	18.0	–	25	31	–	41	10.0	25	20	230	4°	0.72	P1C-4QMSA
125	140	25.0	–	37	40	–	50	10.0	30	30	275	4°	1.53	P1C-4RMSA
160	177	30.0	–	43	44	41	55	4.0	41	35	315	16°	C.F.	L075420160
200	214	30.0	–	43	48	42	60	8.0	42	35	335	16°	C.F.	L075420200

S = Stroke length C.F. = Consult Factory



B
Tie Rod Cylinders
Actuator Products

3MA Series

4MA/4ML Series

3MAJ/4MAJ Series

4MNR Series

P1D Series

Clevis Bracket – MP2



Intended for flexible mounting of cylinder. Clevis bracket MP2 can be combined with clevis bracket MP4.

Materials:

Clevis bracket: Surface-treated aluminium, black for 32-160mm bores; Cast iron for 200mm bore
 Pin: Surface hardened steel
 Circlips according to DIN 471: Spring steel
 Mounting screws acc. to DIN 912: Zinc-plated steel 8.8
 Supplied complete with mounting screws for attachment to cylinder.

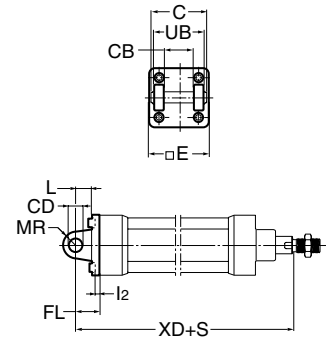

According to ISO MP2, VDMA 24 562, AFNOR

Bore size mm	C mm	E mm	UB h14 mm	CB H14 mm	FL ±0.2 mm	L mm	l2 mm	CD H9 mm	MR mm	XD mm	Weight kg	Part number
32	53	45	45	26	22	13	5.5	10	10	142	0.08	P1C-4KMT
40	60	52	52	28	25	16	5.5	12	12	160	0.11	P1C-4LMT
50	68	65	60	32	27	16	6.5	12	12	170	0.14	P1C-4MMT
63	78	75	70	40	32	21	6.5	16	16	190	0.29	P1C-4NMT
80	98	95	90	50	36	22	10.0	16	16	210	0.36	P1C-4PMT
100	118	115	110	60	41	27	10.0	20	20	230	0.64	P1C-4QMT
125	139	140	130	70	50	30	10.0	25	25	275	1.17	P1C-4RMT
160	178	180	170	90	55	35	10.0	30	25	315	C.F.	L075390160
200	178	200	170	90	60	35	14.0	30	25	335	C.F.	L075390200

S = Stroke length C.F. = Consult Factory

Clevis Bracket – MP4



Intended for flexible mounting of cylinder. Clevis bracket MP4 can be combined with clevis bracket MP2.

Materials:

Clevis bracket: Surface-treated aluminium, black for 32-125mm bores; Cast iron for 160-200mm bores
 Mounting screws acc. to DIN 912: Zinc-plated steel 8.8
 Supplied complete with mounting screws for attachment to cylinder.

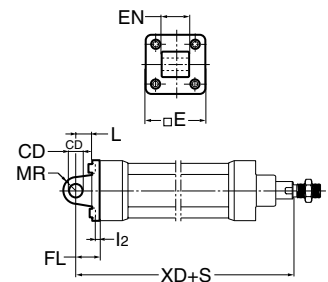

According to ISO MP4, VDMA 24 562, AFNOR

Bore size mm	E mm	EW mm	FL mm	L ±0.2 mm	l2 mm	CD mm	MR H9 mm	XD mm	Weight kg	Part number
32	45	26	22	13	5.5	10	10	142	0.09	P1C-4KME
40	52	28	25	16	5.5	12	12	160	0.13	P1C-4LME
50	65	32	27	16	6.5	12	12	170	0.17	P1C-4MME
63	75	40	32	21	6.5	16	16	190	0.36	P1C-4NME
80	95	50	36	22	10.0	16	16	210	0.46	P1C-4PME
100	115	60	41	27	10.0	20	20	230	0.83	P1C-4QME
125	140	70	50	30	10.0	25	25	275	1.53	P1C-4RME
160	180	90	55	35	10.0	30	25	315	C.F.	L075410160
200	220	90	60	35	14.0	30	25	335	C.F.	L075410200

S = Stroke length C.F. = Consult Factory

B
 Tie Rod Cylinders
 Actuator Products
 3MA Series
 4MA/4ML Series
 3MAJ/4MAJ Series
 4MNR Series
 P1D Series



Clevis Bracket – GA



Intended for flexible mounting of cylinder. Clevis bracket GA can be combined with pivot bracket with swivel bearing, swivel eye bracket and swivel rod eye.

Materials:

- Clevis bracket: Surface-treated aluminium
 - Pin: Surface hardened steel
 - Locking pin: Spring steel
 - Circlips according to DIN 471: Spring steel
 - Mounting screws acc. to DIN 912: Zinc-plated steel 8.8
- Supplied complete with mounting screws for attachment to cylinder.

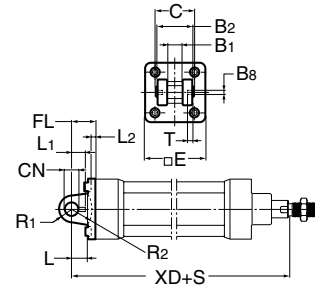

According to VDMA 24 562, AFNOR

Bore size mm	C mm	E mm	B2 d12 mm	B1 H14 mm	T mm	B3 mm	R2 mm	L1 mm	FL ±0.2 mm	I2 mm	L mm	CN F7 mm	R1 mm	XD mm	Weight kg	Part number
32	41	45	34	14	3	3.3	17	11.5	22	5.5	12	10	11	142	0.09	P1C-4KMCA
40	48	52	40	16	4	4.3	20	12.0	25	5.5	15	12	13	160	0.13	P1C-4LMCA
50	54	65	45	21	4	4.3	22	14.0	27	6.5	17	16	18	170	0.17	P1C-4MMCA
63	60	75	51	21	4	4.3	25	14.0	32	6.5	20	16	18	190	0.36	P1C-4NMCA
80	75	95	65	25	4	4.3	30	16.0	36	10.0	20	20	22	210	0.58	P1C-4PMCA
100	85	115	75	25	4	4.3	32	16.0	41	10.0	25	20	22	230	0.89	P1C-4QMCA
125	110	140	97	37	6	6.3	42	24.0	50	10.0	30	30	30	275	1.75	P1C-4RMCA
160	140	178	122	43	6	6.3	46	26.5	55	10.0	37	35 h9	36	C.F.	C.F.	L075510160
200	175	218	122	43	6	6.3	49	26.5	60	11.5	40	35 h9	38	C.F.	C.F.	L075510200

S = Stroke length C.F. = Consult Factory

Head Detachable Clevis – MP7

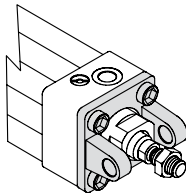

Intended for flexible mounting of cylinder

Materials:

- Clevis bracket: Cast iron for 32-63mm bores;
 - Surface treated aluminum, black for 80-200mm bores
 - Mounting screws acc. to DIN 912: Zinc-plated steel 8.8
- Supplied complete with mounting screws for attachment to cylinder.

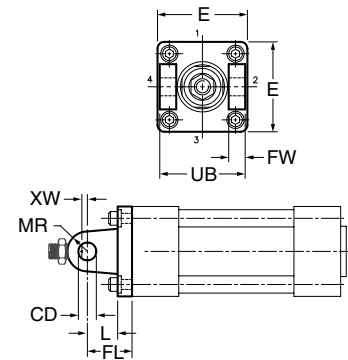

According to ISO MP7, VDMA 24 562, AFNOR

Bore size mm	CD mm	E mm	FL mm	FW mm	L mm	MR mm	UB mm	XW mm	Part number
32	10	46.5	22	8	12	10	45	4	L075400032
40	12	52	25	9	15	12	52	5	L075400040
50	12	63.5	27	10	15	13	60	10	L075400050
63	16	76	32	15	20	16	70	5	L075400063
80	16	95.5	36	20	20	17	90	10	L075400080
100	20	114.5	41	25	25	21	110	10	L075400100
125	25	140	50	30	35	25	130	15	L075400125
160	30	177	55	40	36	30	170	25	L075400160
200	30	214	60	40	41	30	170	35	L075400200



B

Tie Rod Cylinders Actuator Products

3MA Series

4MA/4ML Series

3MAJ/4MAJ Series

4MNR Series

P1D Series

Pivot Bracket with Swivel Bearing



Intended for use together with clevis bracket GA.

Materials:

Pivot bracket: Surface-treated steel, black
 Swivel bearing acc. to DIN 648K: Hardened steel

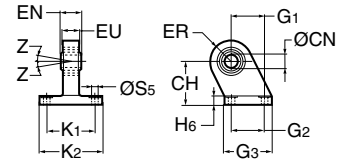

According to VDMA 24 562, AFNOR

Bore size mm	CN H7 mm	S5 H13 mm	K1 JS14 mm	K2 mm	EU mm	G1 JS14 mm	G2 JS14 mm	EN mm	G3 mm	CH JS15 mm	H6 mm	ER mm	Z	Weight kg	Part number
32	10	6.6	38	51	10.5	21	18	14	31	32	10	16	4°	0.18	P1C-4KMA
40	12	6.6	41	54	12.0	24	22	16	35	36	10	18	4°	0.25	P1C-4LMA
50	16	9.0	50	65	15.0	33	30	21	45	45	12	21	4°	0.47	P1C-4MMA
63	16	9.0	52	67	15.0	37	35	21	50	50	12	23	4°	0.57	P1C-4NMA
80	20	11.0	66	86	18.0	47	40	25	60	63	14	28	4°	1.05	P1C-4PMA
100	20	11.0	76	96	18.0	55	50	25	70	71	15	30	4°	1.42	P1C-4QMA
125	30	14.0	94	124	25.0	70	60	37	90	90	20	40	4°	3.10	P1C-4RMA

Mounting Kit



Mounting kit for back to back mounted cylinders, 3 and 4 position duplex cylinders.

Materials:

Mounting: Aluminium
 Mounting screws: Zinc-plated steel 8.8

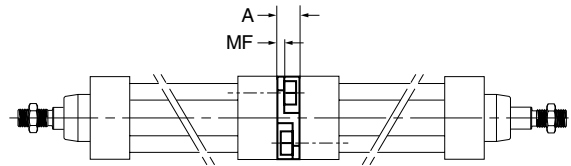

Bore size mm	E mm	TG mm	ØFB mm	MF mm	A mm	ØBA mm	Weight kg	Part number
32	50	32.5	6.5	5	16	30	0.060	P1E-6KB0
40	60	38.0	6.5	5	16	35	0.078	P1E-6LB0
50	66	46.5	8.5	6	20	40	0.162	P1E-6MB0
63	80	56.5	8.5	6	20	45	0.194	P1E-6NB0
80	100	72.0	10.5	8	25	45	0.450	P1E-6PB0
100	118	89.0	10.5	8	25	55	0.672	P1E-6QB0

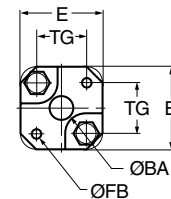

Pivot Bracket – MT4



Intended for use together with central trunnion MT4.

Materials:

Pivot bracket: Surface-treated aluminium
 Bearing acc. to DIN 1850 C: Sintered oil-bronze bushing
 Supplied in pairs.

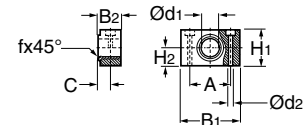

According to ISO, VDMA 24 562, AFNOR

Bore size mm	B1 mm	B2 mm	A mm	C mm	d1 mm	d2 H13 mm	H1 mm	H2 mm	fx45° min mm	Weight* kg	Part number
32	46	18.0	32	10.5	12	6.6	30	15	1.0	0.04	9301054261
40	55	21.0	36	12.0	16	9.0	36	18	1.6	0.07	9301054262
50	55	21.0	36	12.0	16	9.0	36	18	1.6	0.07	9301054262
63	65	23.0	42	13.0	20	11.0	40	20	1.6	0.12	9301054264
80	65	23.0	42	13.0	20	11.0	40	20	1.6	0.12	9301054264
100	75	28.5	50	16.0	25	14.0	50	25	2.0	0.21	9301054266
125	75	28.5	50	16.0	25	14.0	50	25	2.0	0.21	9301054266

* Weight per item



Intermediate Trunnion – MT4



Standard*



Tie Rod Version

Intended for articulated mounting of cylinder. The trunnion is factory-fitted at an optional location. Order by specifying Mounting Style G or 7 and providing the desired XV dimension (3-digit measure in mm). See page B67 for ordering information. Combined with pivot bracket for MT4 for 32-125mm bores.

Materials:

Trunnion: Zinc plated steel
 (Cast iron for 160-200mm bores)

* Standard mounting is for the Standard cylinder body and is permanently affixed by the factory.

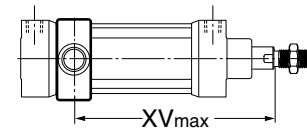
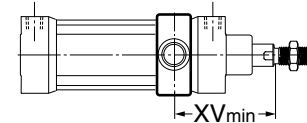
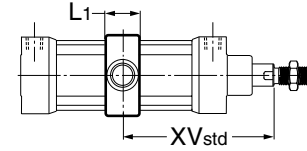
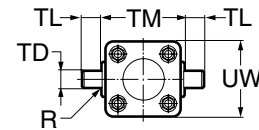

According to ISO MT4, VDMA 24 562, AFNOR

Bore size mm	TM h14 mm	TL h14 mm	TD e9 mm	R mm	UW mm	L1 mm	X1 mm	XVmin mm	X2 mm	Weight kg
32	50	12	12	1.0	46	15	73.0	62.0	84.0	0.13
40	63	16	16	1.6	59	20	82.5	73.0	92.0	0.31
50	75	16	16	1.6	69	20	90.0	80.5	99.5	0.37
63	90	20	20	1.6	84	25	97.5	89.5	106.0	0.69
80	110	20	20	1.6	102	25	110.0	98.0	122.0	0.89
100	132	25	25	2.0	125	30	120.0	110.5	129.5	1.58
125	160	25	25	2.0	155	32	145.0	132.0	158.0	2.60
160	200	32	32	2.5	190	70	C.F.	169	C.F.	C.F.
200	250	32	32	2.5	242	70	C.F.	184	C.F.	C.F.

$XV_{std} = X1 + \text{Stroke length}/2$

$XV_{max} = X2 + \text{Stroke length}$

C.F. = Consult Factory

Flange Mounted Trunnion



Intended for articulated mounting of cylinder. This trunnion can be flange mounted on the front or rear end cover of all P1D cylinders. If you choose, you can order a complete cylinder with factory-fitted flange mounted trunnion – see the ordering information on page B67 Individual trunnions have part numbers as shown below.

Materials:

Trunnion: zinc plated steel
 Screws: zinc plated steel, 8.8

Delivered complete with mounting screws for attachment to the cylinder

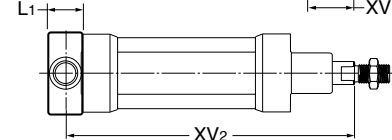
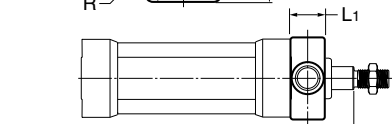
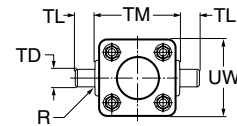

According to ISO MT4, VDMA 24 562, AFNOR

Bore size mm	TM h14 mm	TL h14 mm	TD e9 mm	R mm	UW mm	L1 mm	XV1 mm	X mm	Weight kg	Part number
32	50	12	12	1.0	46	14	19.0	127.0	0.17	P1D-4KMYF
40	63	16	16	1.6	59	19	20.5	144.5	0.43	P1D-4LMYF
50	75	16	16	1.6	69	19	27.5	152.5	0.55	P1D-4MMYF
63	90	20	20	1.6	84	24	25.0	170.0	1.10	P1D-4NMYF
80	110	20	20	1.6	102	24	34.0	186.0	1.66	P1D-4PMYF
100	132	25	25	2.0	155	29	36.5	203.5	3.00	P1D-4QMYF

$XV2 = X + \text{Stroke length}$

B	Tie Rod Cylinders
	Actuator Products
3MA Series	
4MA/4ML Series	
3MAJ/4MAJ Series	
4MNR Series	
P1D Series	



Swivel Rod Eye



Stainless Steel Swivel Rod Eye

Swivel rod eye for articulated mounting of cylinder.
 Swivel rod eye can be combined with clevis bracket GA.
 Maintenance-free.

Materials:

Swivel rod eye: Zinc-plated steel
 Swivel bearing according to DIN 648K: Hardened steel

Swivel rod eye: Stainless steel
 Swivel bearing according to DIN 648K: Stainless steel

Use stainless steel nut (see next page) with stainless steel swivel rod eye.

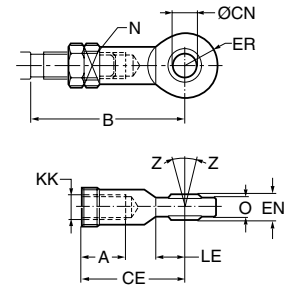

According to ISO 8139

Bore size mm	A mm	B min mm	B max mm	CE mm	CN H9 mm	EN h12 mm	ER mm	KK	LE min mm	N mm	O mm	Z	Weight kg	Part number	Stainless steel part number
32	20	48.0	55	3	10	14	14	M10x1.25	15	17	10.5	12°	0.08	P1C-4KRS	P1S-4JRT
40	22	56.0	62	50	12	16	16	M12x1.25	17	19	12.0	12°	0.12	P1C-4LRS	P1S-4LRT
50	28	72.0	80	64	16	21	21	M16x1.5	22	22	15.0	15°	0.25	P1C-4MRS	P1S-4MRT
63	28	72.0	80	64	16	21	21	M16x1.5	22	22	15.0	15°	0.25	P1C-4PRS	P1S-4PRT
80	33	87.0	97	77	20	25	25	M20x1.5	26	32	18.0	15°	0.46	P1C-4RRS	P1S-4RRT
100	33	87.0	97	77	20	25	25	M20x1.5	26	32	18.0	15°	0.46	P1C-4RRS	P1S-4RRT
125	51	123.5	137	110	30	37	35	M27x2	36	41	25.0	15°	1.28	P1C-4RRS	P1S-4RRT
160/200	56	C.F.	C.F.	125	35*	43	40	M36x2	40	50	28.0	15°	C.F.	L075470036	C.F.

*H7 C.F. = Consult Factory

Clevis



Stainless Steel Clevis

Clevis for articulated mounting of cylinder.

Materials:

Clevis, clip: Galvanized steel
 Pin: Hardened steel

Clevis: Stainless steel
 Pin: Stainless steel
 Circlips according to DIN 471: Stainless steel

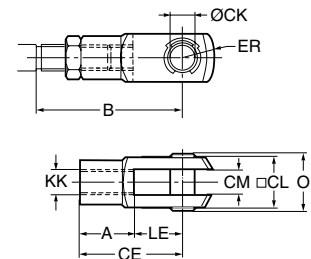

According to ISO 8140

Bore size mm	A mm	B min mm	B max mm	CE mm	CK h11/E9 mm	CL mm	CM mm	ER mm	KK	LE mm	O mm	Weight kg	Part number	Stainless steel part number
32	20	45.0	52	40	10	20	10	16	M10x1.25	20	28.0	0.09	P1C-4KRC	P1S-4JRD
40	24	54.0	60	48	12	24	12	19	M12x1.25	24	32.0	0.15	P1C-4LRC	P1S-4LRD
50	32	72.0	80	64	16	32	16	25	M16x1.5	32	41.5	0.35	P1C-4MRC	P1S-4MRD
63	32	72.0	80	64	16	32	16	25	M16x1.5	32	41.5	0.35	P1C-4MRC	P1S-4MRD
80	40	90.0	100	80	20	40	20	32	M20x1.5	40	50.0	0.75	P1C-4PRC	P1S-4PRD
100	40	90.0	100	80	20	40	20	32	M20x1.5	40	50.0	0.75	P1C-4PRC	P1S-4PRD
125	56	123.5	137	110	30	55	30	45	M27x2	54	72.0	2.10	P1C-4RRC	P1S-4RRD
160/200	71	C.F.	C.F.	144	35	70	35	57	M36x2	72	95	C.F.	L075490036	C.F.

C.F. = Consult Factory



Flexo Coupling



Flexo coupling for articulated mounting of piston rod. Flexo fitting is intended to take up axial angle errors within a range of $\pm 4^\circ$.

Materials:

Flexo coupling, nut: Zinc-plated steel
 Socket: Hardened steel
 Supplied complete with galvanized adjustment nut.

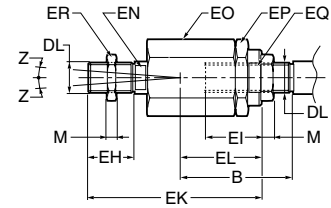

Bore size mm	B min mm	B max mm	DL	EH mm	EI mm	EK mm	EL mm	EN mm	EO mm	EP mm	EQ mm	ER mm	M mm	Z	Weight kg	Part number
32	36.0	43	M10x1.25	20	23	70	31	12	30	30	19	30	5.0	4°	0.21	P1C-4KRF
40	37.0	43	M12x1.25	23	23	67	31	12	30	30	19	30	6.0	4°	0.22	P1C-4LRF
50	53.0	61	M16x1.5	40	32	112	45	19	41	41	30	41	8.0	4°	0.67	P1C-4MRF
63	53.0	61	M16x1.5	40	32	112	45	19	41	41	30	41	8.0	4°	0.67	P1C-4PRF
80	57.0	67	M20x1.5	39	42	122	56	19	41	41	30	41	10.0	4°	0.72	P1C-4RRF
100	57.0	67	M20x1.5	39	42	122	56	19	41	41	30	41	10.0	4°	0.72	P1C-4RRF
125	75.5	89	M27x2	48	48	145	60	24	55	55	32	55	13.5	4°	1.80	P1C-4RRF
160/200	C.F.	C.F.	M36x2	72	78	251	C.F.	36	75	75	50	55	18.0	4°	C.F.	L075530036

C.F. = Consult Factory

Nuts



Intended for fixed mounting of accessories to the piston rod.

Material: Zinc-plated steel

All P1D cylinders are delivered with a zinc-plated steel piston rod nut, except P1D Clean, which is delivered with a stainless steel piston rod nut instead.

Stainless Steel Nut

Material: Stainless steel A2

All P1D cylinders are delivered with a zinc-plated steel piston rod nut, except P1D Clean, which is delivered with a stainless steel piston rod nut instead.

Acid-proof nut

Material: Acid-proof steel A4

Cylinders with acid-proof piston rod are supplied with nut of acid-proof steel.

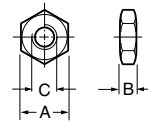

According to DIN 439 B

Bore size mm	A mm	B mm	C	Weight kg	Part numbers		
					Steel	Stainless steel	Acid-proof
32	17	5.0	M10x1.25	0.007	9128985601	9126725404	0261109919
40	19	6.0	M12x1.25	0.010	0261109910	9126725405	0261109920
50	24	8.0	M16x1.5	0.021	9128985603	9126725406	0261109917
63	24	8.0	M16x1.5	0.021			
80	30	10.0	M20x1.5	0.040	0261109911	0261109921	0261109916
100	30	10.0	M20x1.5	0.040			
125	41	13.5	M27x2	0.100	0261109912	0261109922	0261109918
160/200	55	18.0	M36x2	C.F.	L075540036	C.F.	C.F.

C.F. = Consult Factory

B
 Tie Rod Cylinders
 Actuator Products

3MA Series

4MA/4ML Series

3MAJ/4MAJ Series

4MNR Series

P1D Series



Service Kits: P1D-S, P1D-T, P1D-C, and P1D-F Versions

Cylinder bore mm	P1D cylinder version
	Consisting of: piston, rod and o-ring seals
32	SK032P1D01
40	SK040P1D01
50	SK050P1D01
63	SK063P1D01
80	SK080P1D01
100	SK100P1D01
125	SK125P1D01

Gland Service Kits: P1D-G and P1D-E Versions

Bore size mm	Rod dia. mm	Rod no.	RG-rod gland cartridge kit Consisting of: rod gland, seals, and wiper		RK-rod seal kit Consisting of: gland seals, and wiper	
			Nitrile seals part number	Fluorocarbon seals part number	Nitrile seals part number	Fluorocarbon seals Part number
32	12	1	RG0P1D0121	RG0P1D0125	RK0P1D0121	RK0P1D0125
40	16	1	RG0P1D0161	RG0P1D0165	RK0P1D0161	RK0P1D0165
50 & 63	20	1	RG0P1D0201	RG0P1D0205	RK0P1D0201	RK0P1D0205
80 & 100	25	1	RG0P1D0251	RG0P1D0255	RK0P1D0251	RK0P1D0255
125	32	1	RG0P1D0321	RG0P1D0325	RK0P1D0321	RK0P1D0325

Piston and End Seal Service Kits: P1D-G and P1D-E Versions

Bore size mm	PK – piston seal kit Consisting of: piston seals, wear ring, and magnetic strip (nitrile only)		CB – cylinder body end seal kit Consisting of: end seal o-rings	
	Nitrile seals part number	Fluorocarbon seals part number	Nitrile seals part number	Fluorocarbon seals part number
32	PK032P1D01	PK032P1D05	CB032P1D01	CB032P1D05
40	PK040P1D01	PK040P1D05	CB040P1D01	CB040P1D05
50	PK050P1D01	PK050P1D05	CB050P1D01	CB050P1D05
63	PK063P1D01	PK063P1D05	CB063P1D01	CB063P1D05
80	PK080P1D01	PK080P1D05	CB080P1D01	CB080P1D05
100	PK100P1D01	PK100P1D05	CB100P1D01	CB100P1D05
125	PK125P1D01	PK125P1D05	CB125P1D01	CB125P1D05

B
 Tie Rod Cylinders
 Actuator Products
 Series
 3MA
 4MA/4ML
 3MAJ/4MAJ
 Series
 4MNR
 Series
 P1D
 Series